

VEGAS 37

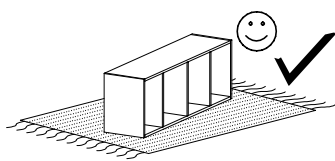

Narzędzia potrzebne do montażu

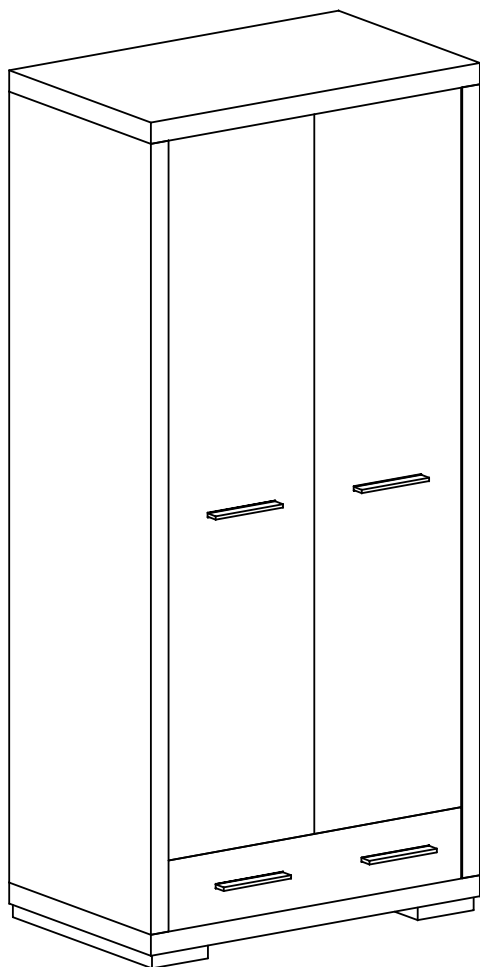

UWAGA !!!

MONTOWANIE USZKODZONYCH
ELEMENTÓW POWODUJE UTRATĘ
GWARANCJI

Nr	D[mm]	S[mm]	G[mm]	Ilość
1	883	542	48	1
2	883	542	48	1
3	848	522	16	1
4	1793	540	48	1
5	1793	540	48	1
6	1820	890	2,5	1
7	780	190	16	1
8	500	165	16	1
9	726	165	16	1
10	500	165	16	1
11	757	505	2,5	1
12	388	1590	16	1
13	388	1590	16	1

W przypadku reklamacji proszę podać numer pakowacza znajdujący się na kartonie.

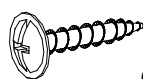

Q - 4 St.
3,5x16 mm

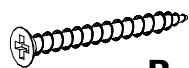

R - 6 St.
4x60 mm



X1 - 6 St.



X2 - 2 St.

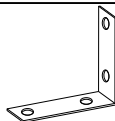

Y - 2 St.



O - 1 St.

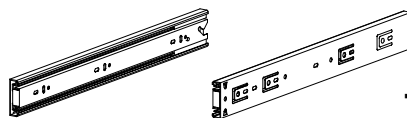

T - 1 Kpl.



F - 4 St.

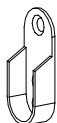

A - 2 St.



N - 8 St.
4x30 mm



U - 4 St.

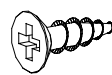

G - 16 St.
3,5x16 mm



L - 18 St.



M - 20 St.
3x30 mm

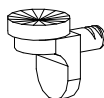

P - 2 St.

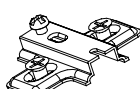

C - 6 St.

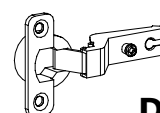

D - 6 St.



S - 1 St.



E - 60 St.



B - 20 St.

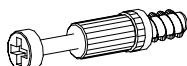

K - 18 St.

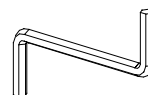

Z - 1 St.



J - 8 St.
5x13 mm

I

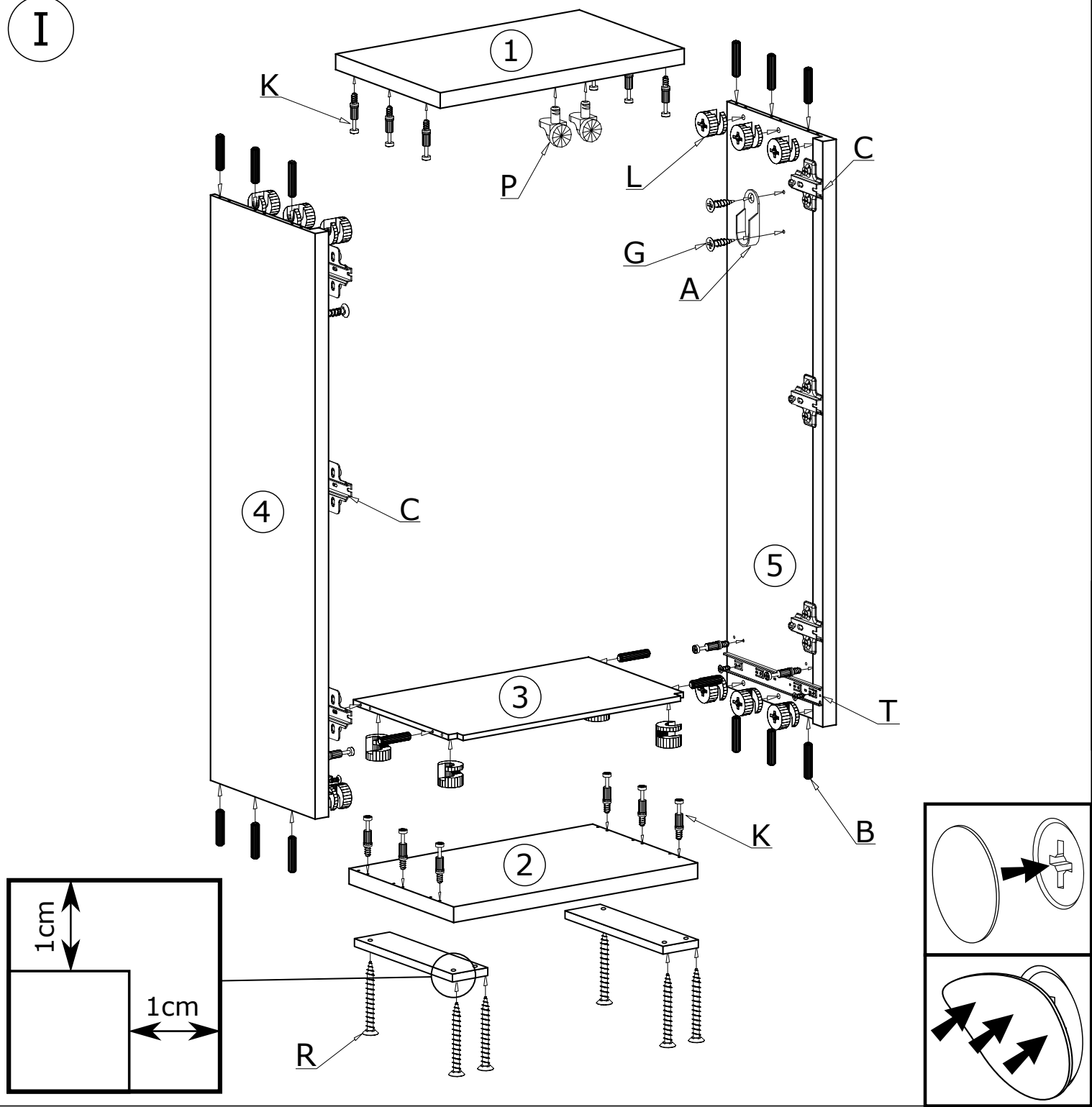

II

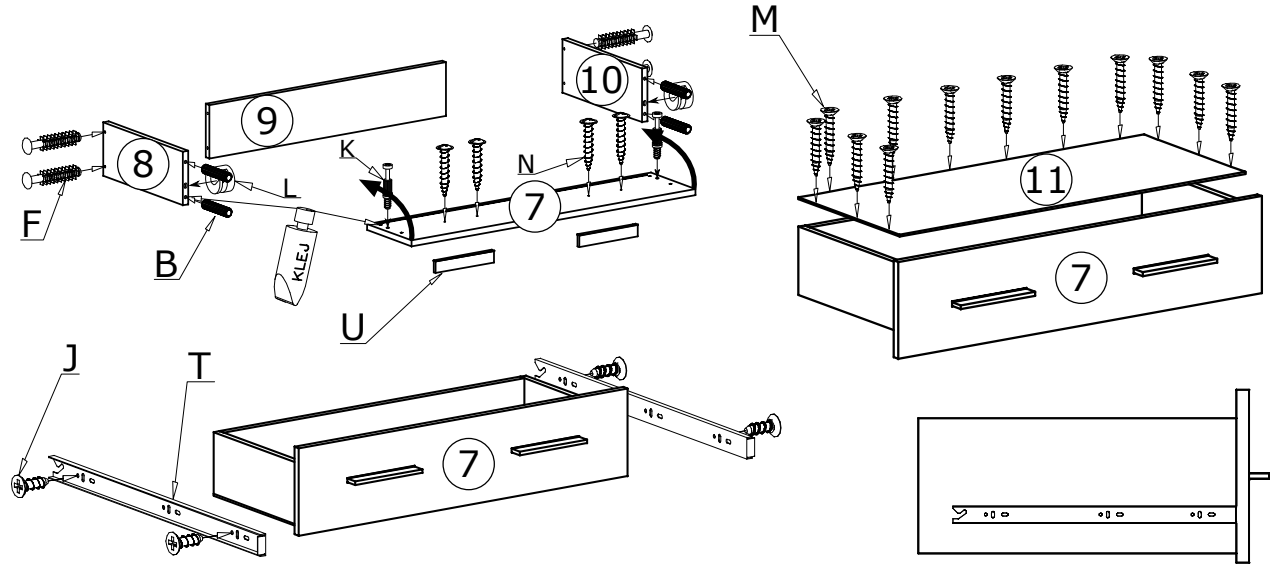

III

60X 

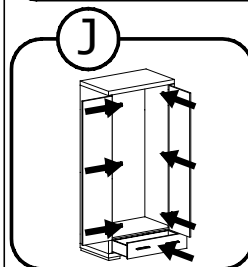
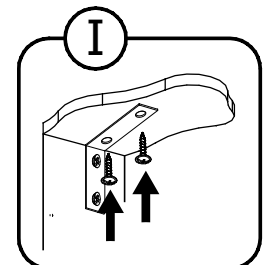
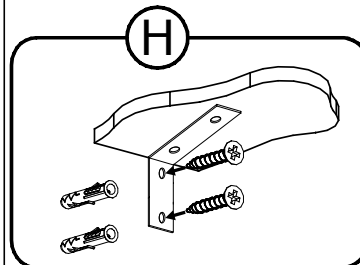
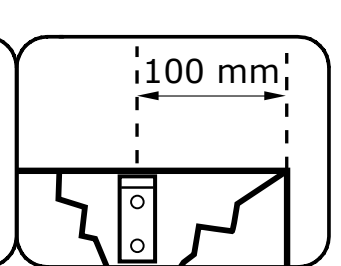
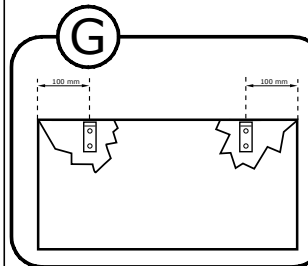
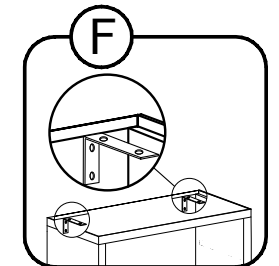
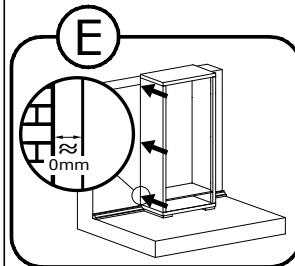
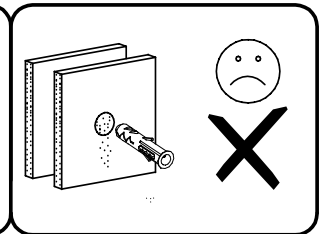
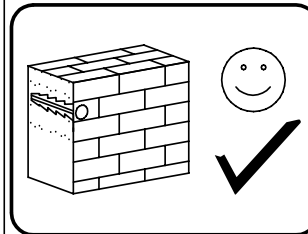
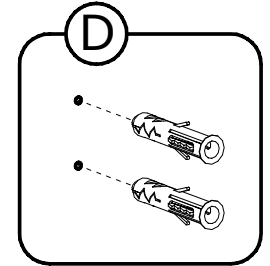
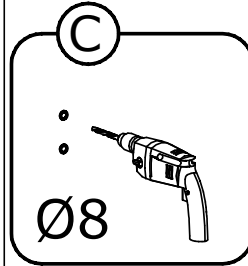
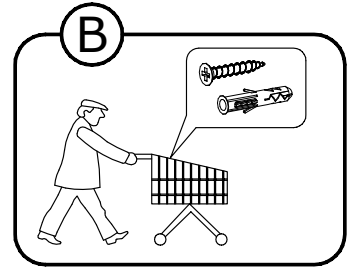
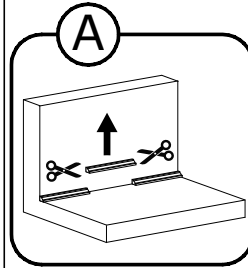
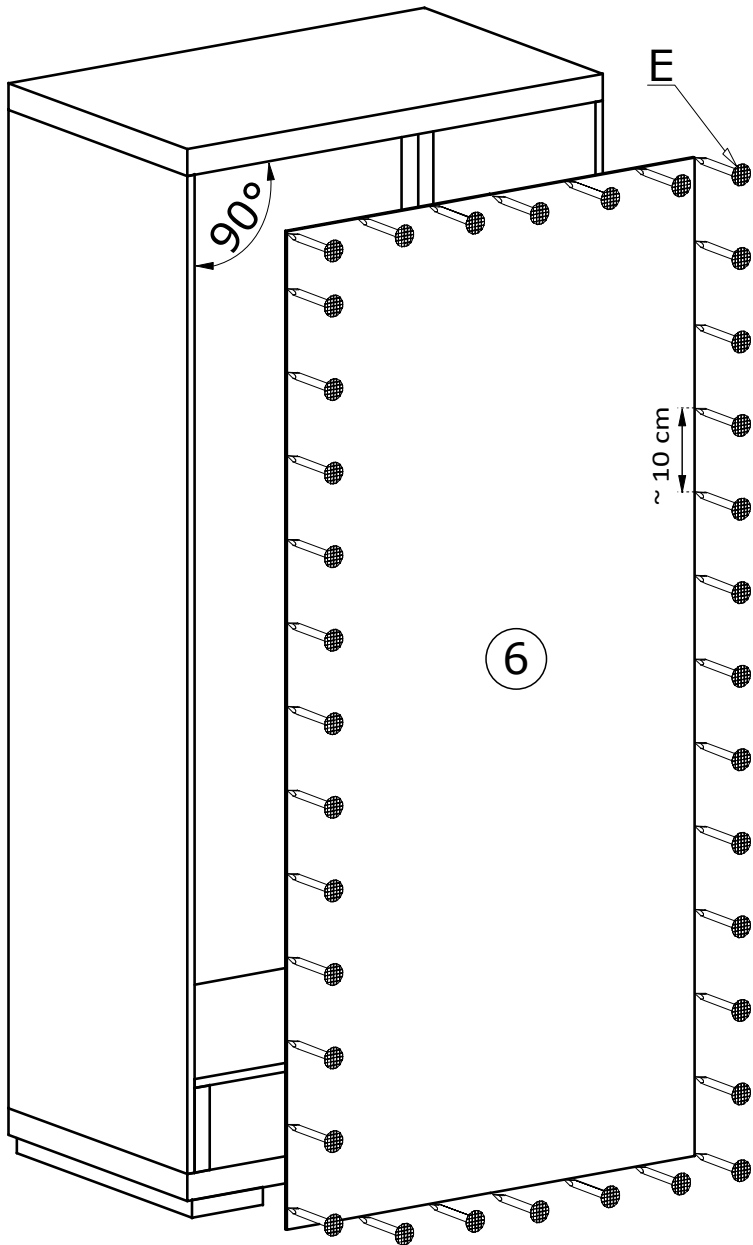

IV

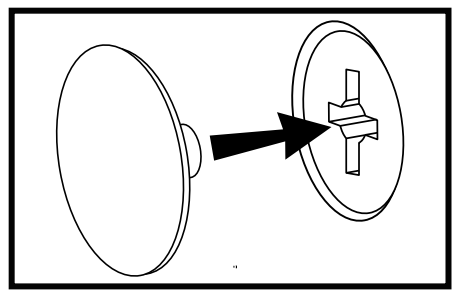
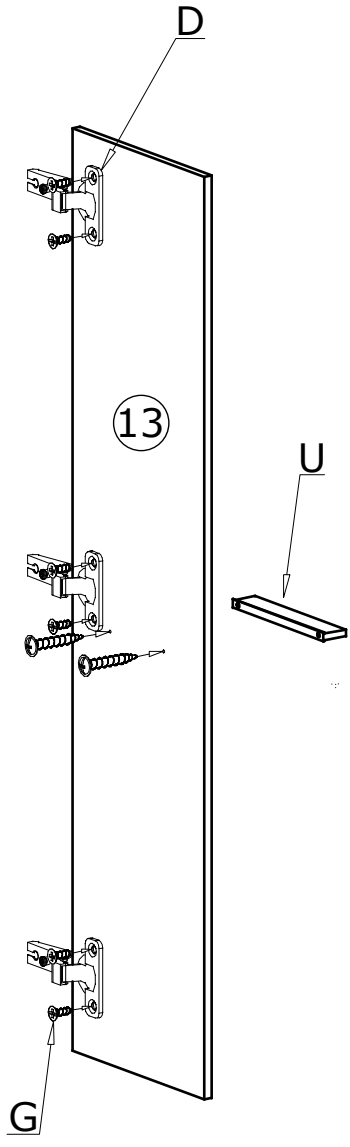
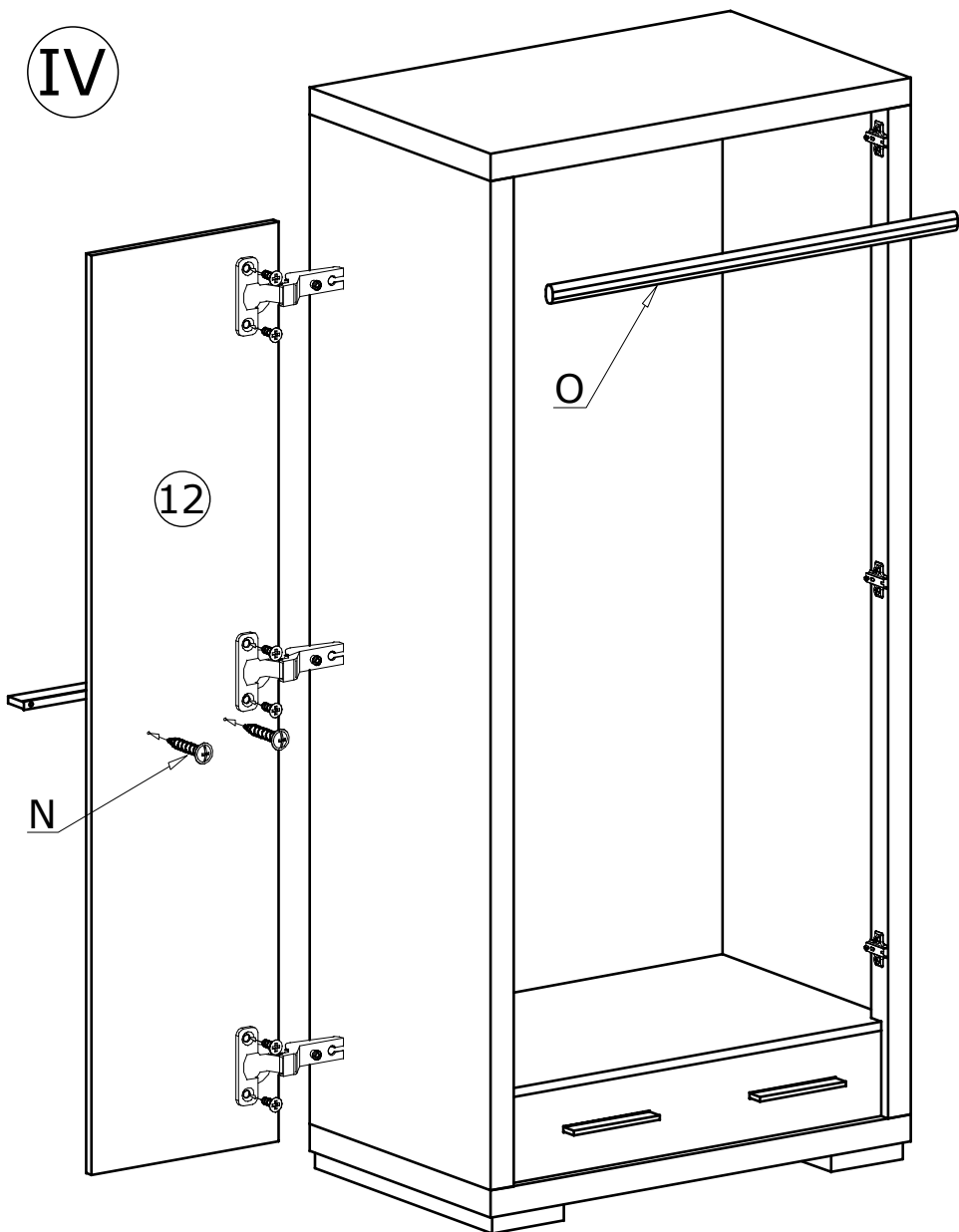

MONTAŻ/DEMONTAŻ PROWADNIC

1



2

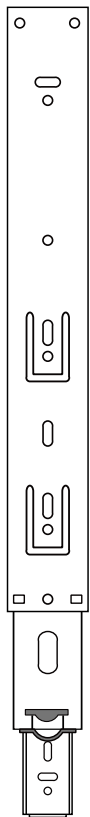

3

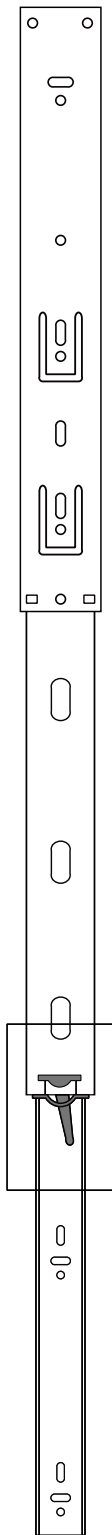

4

