

VEGAS 28

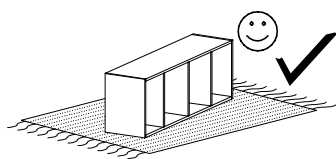

Narzędzia potrzebne do montażu

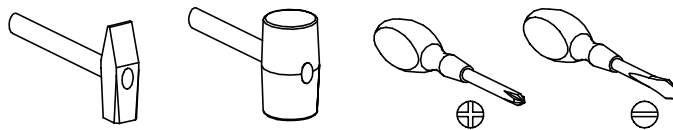

UWAGA !!!

MONTOWANIE USZKODZONYCH
ELEMENTÓW POWODUJE UTRATĘ
GWARANCJI

Nr	D[mm]	S[mm]	G[mm]	Ilość
1	1201	602	48	1
2	727	550	48	1
3	649	550	48	1
4	649	550	48	1
5	501	552	48	1
6	653	200	16	1
7	646	465	16	1
8	627	350	16	1
9	344	107	16	1
10	500	107	16	1
11	505	375	2,5	1
12	395	156	16	1
13	500	107	16	1

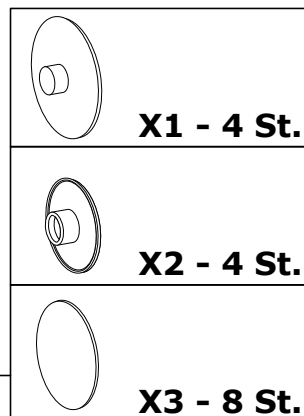
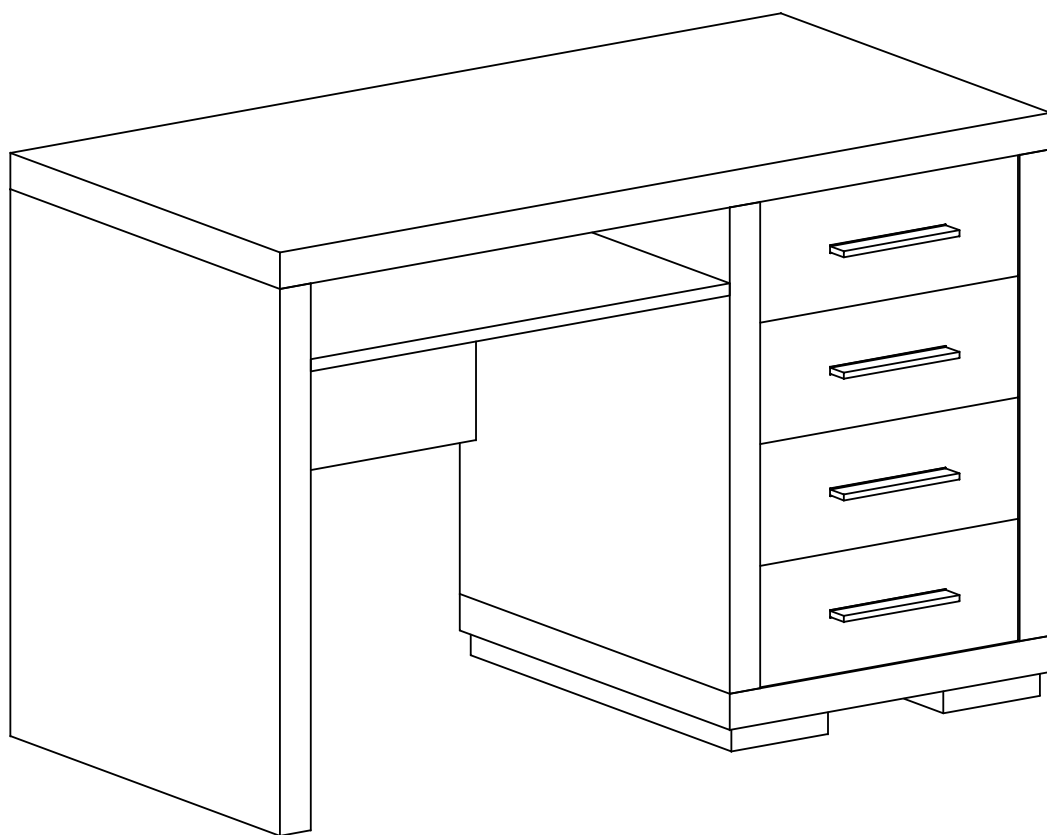

W przypadku reklamacji proszę podać numer pakowacza znajdujący się na kartonie.

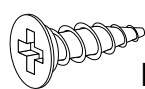

D - 4 St.
3,5x16 mm



Q - 2 St.

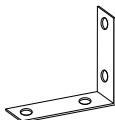

Y - 2 St.

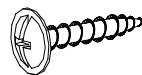

I - 4 St.
3,5x16 mm

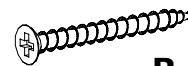

R - 6 St.
4x60 mm

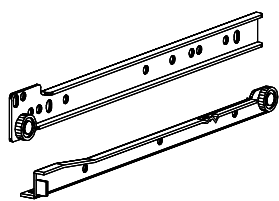

A - 1 Kpl.

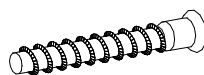

W - 6 St.



M - 80 St.
3x30 mm



N - 8 St.
4x30 mm



L - 20 St.



B - 28 St.



U - 4 St.

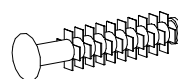

F - 16 St.



S - 1 St.

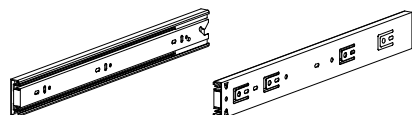

T - 4 Kpl.

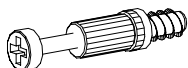

K - 20 St.

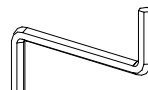

Z - 1 St.



J - 36 St.
5x13 mm

III

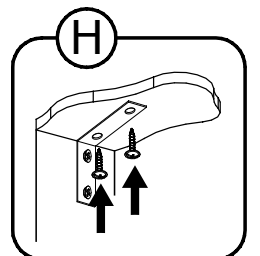
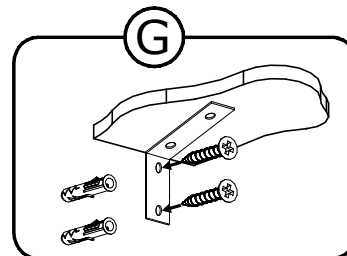
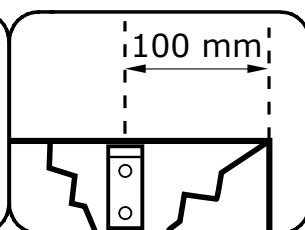
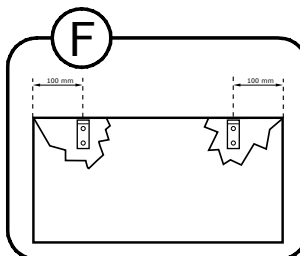
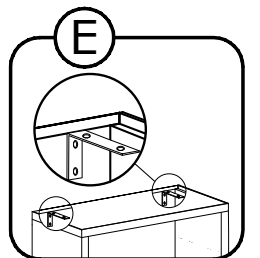
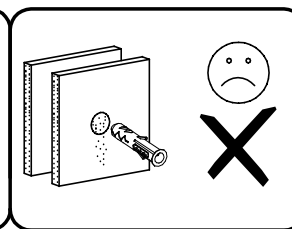
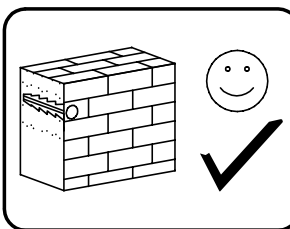
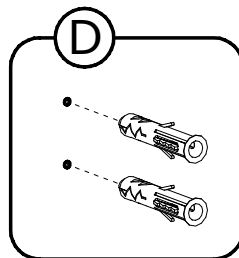
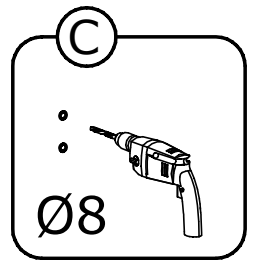
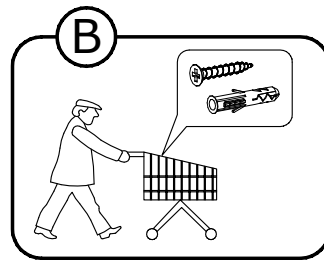
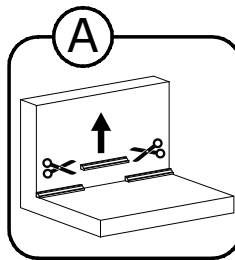
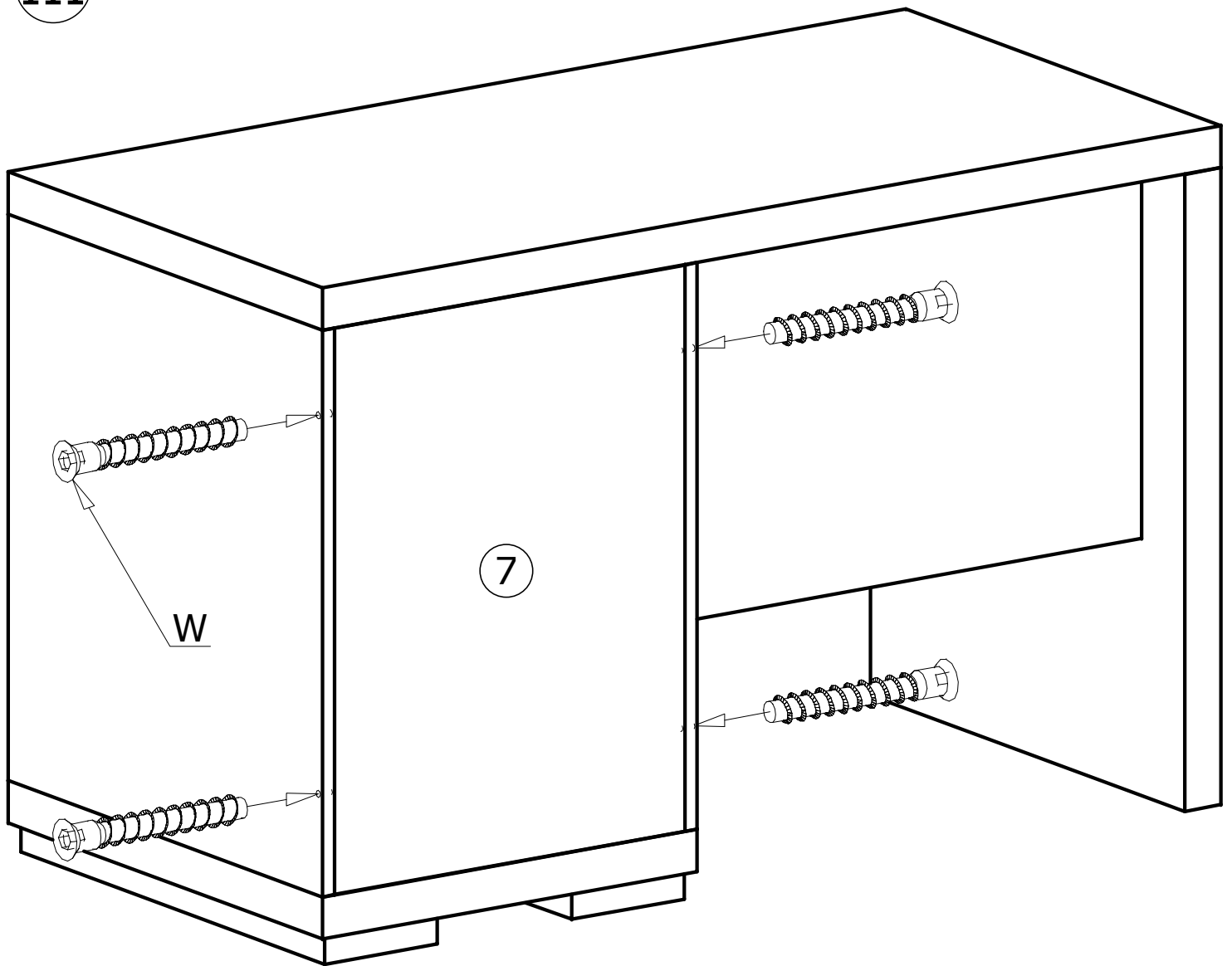

IV

