

VEGAS 13

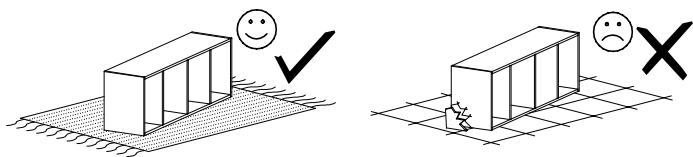

Narzędzia potrzebne do montażu

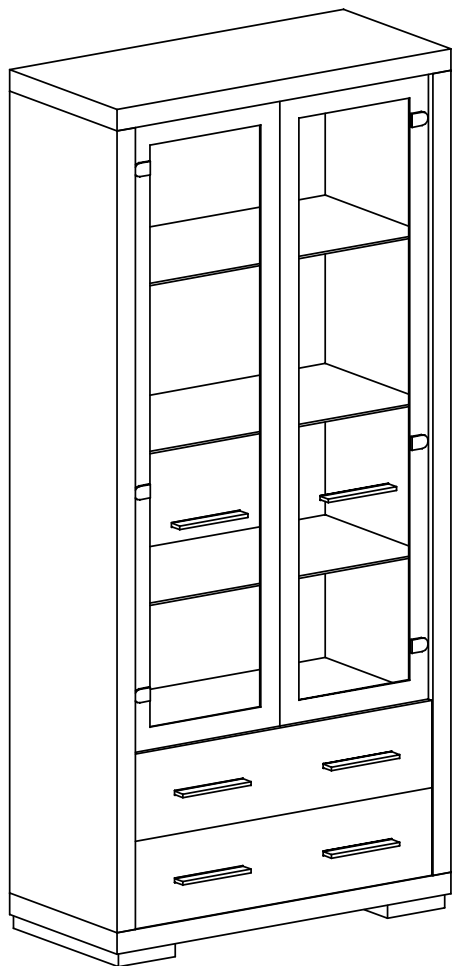
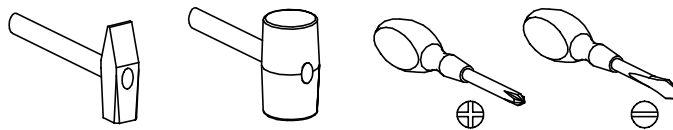

UWAGA !!!

MONTOWANIE USZKODZONYCH
ELEMENTÓW POWODUJE UTRATĘ
GWARANCJI

Nr	D[mm]	S[mm]	G[mm]	Ilość
1	883	407	48	1
2	883	407	48	1
3	1793	405	48	1
4	1793	405	48	1
5	848	398	16	1
6	848	320	4	3
7	350	165	16	2
8	727	165	16	2
9	350	165	16	2
10	757	355	2,5	2
11	780	190	16	2
12	1820	870	2,5	1
13	388	1394	4	1
14	388	1394	4	1

W przypadku reklamacji proszę podać numer pakowacza znajdujący się na kartonie.

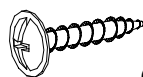

Q - 4 St.
3,5x16 mm

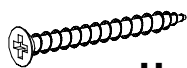

H - 6 St.
4x60 mm

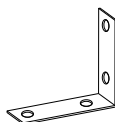

Y - 2 St.

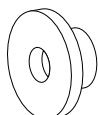

I - 4 St.



M - 60 St.
3x30 mm



G - 4 St.
4x20 mm

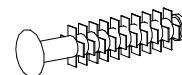

F - 8 St.

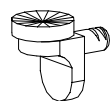

P - 14 St.



N - 8 St.
4x30 mm



U - 6 St.

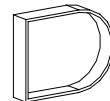

R - 6 St.



L - 16 St.

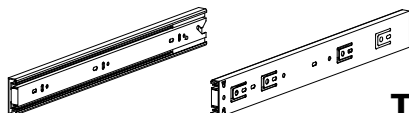

T - 2 Kpl.

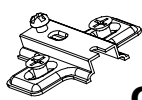

C - 6 St.

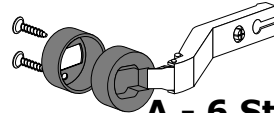

A - 6 St.



S - 1 St.



E - 70 St.



B - 20 St.

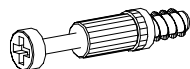

K - 16 St.

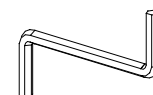

Z - 1 St.



J - 16 St.
5x13 mm

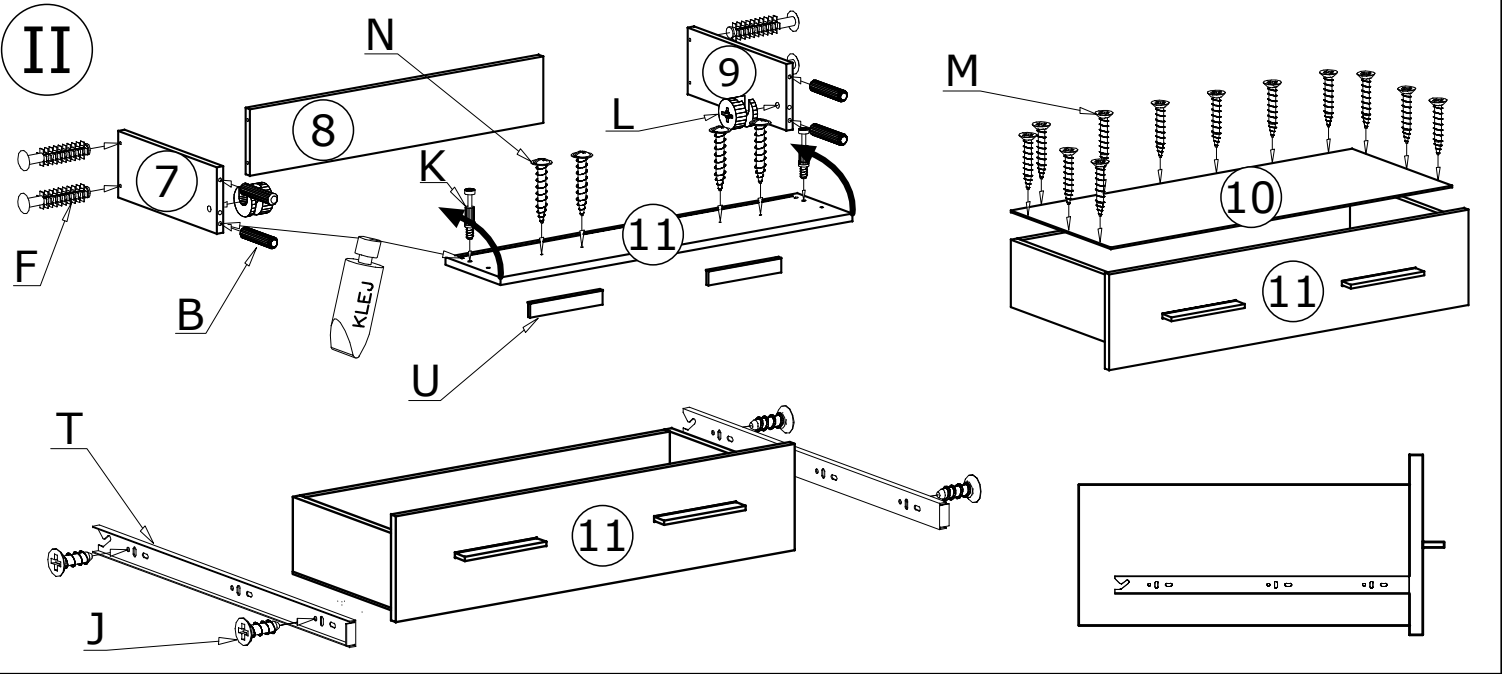
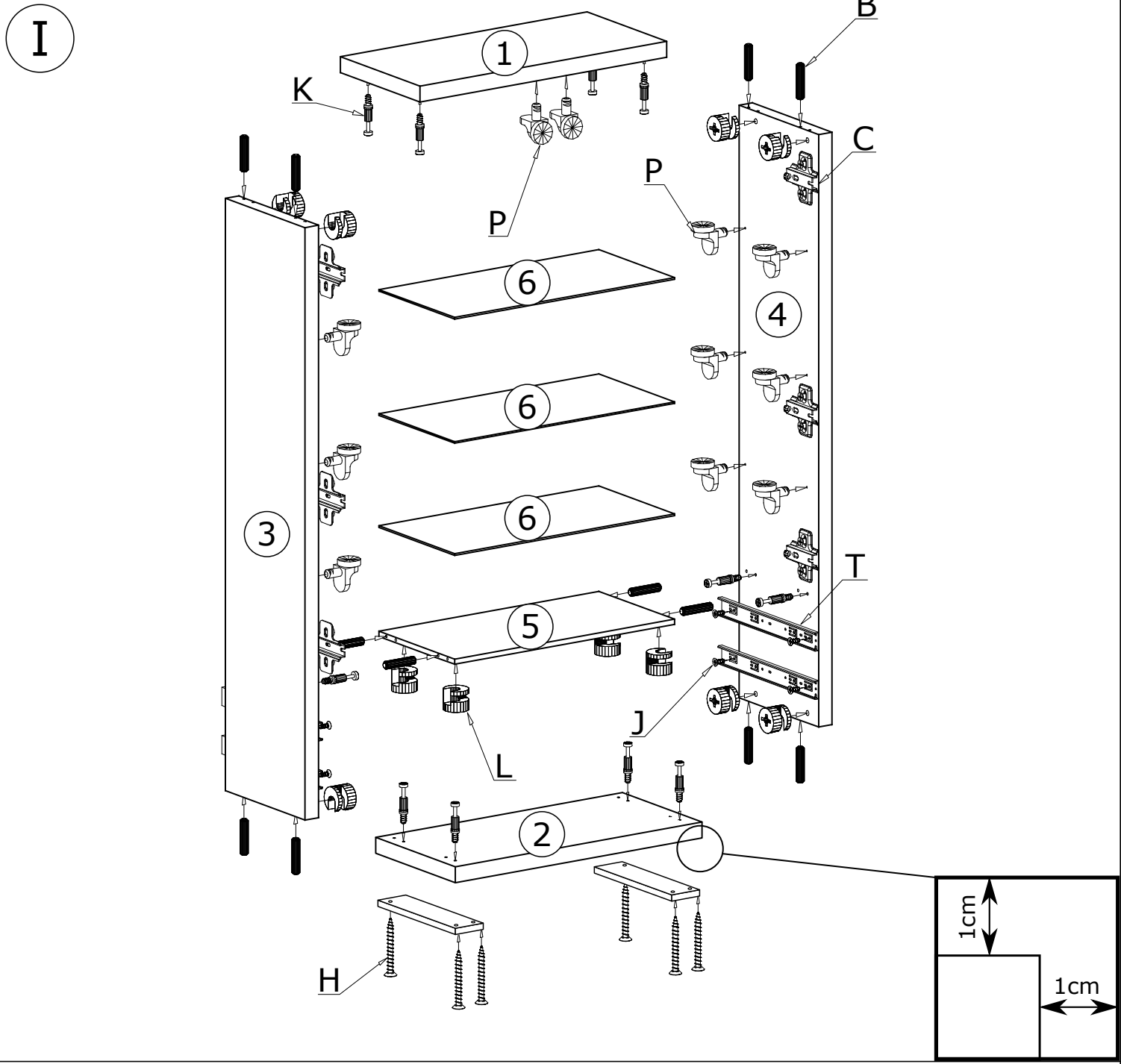

III

70X 

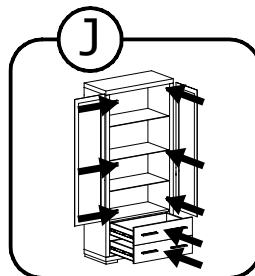
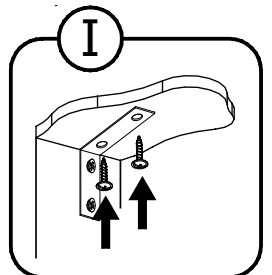
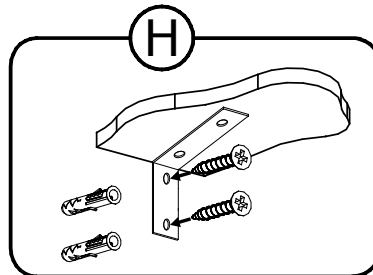
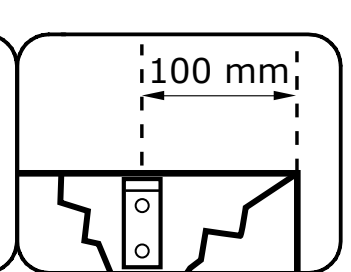
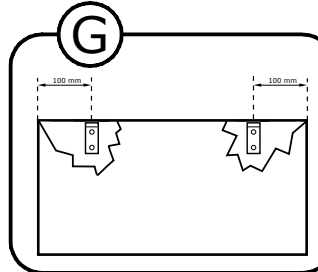
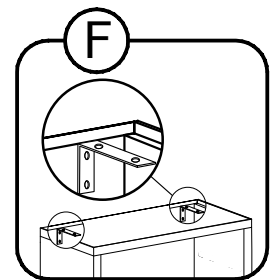
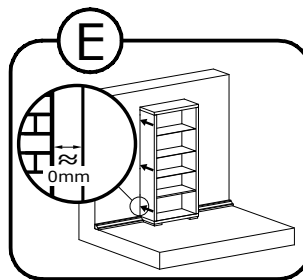
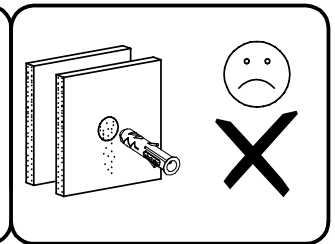
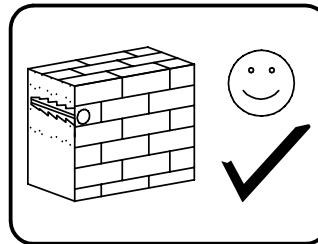
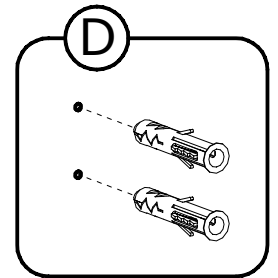
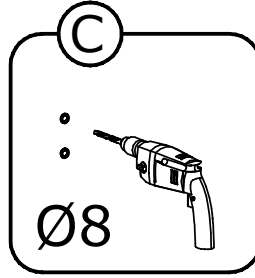
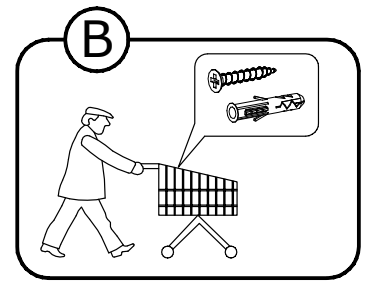
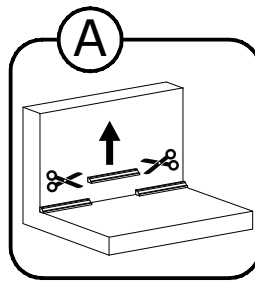
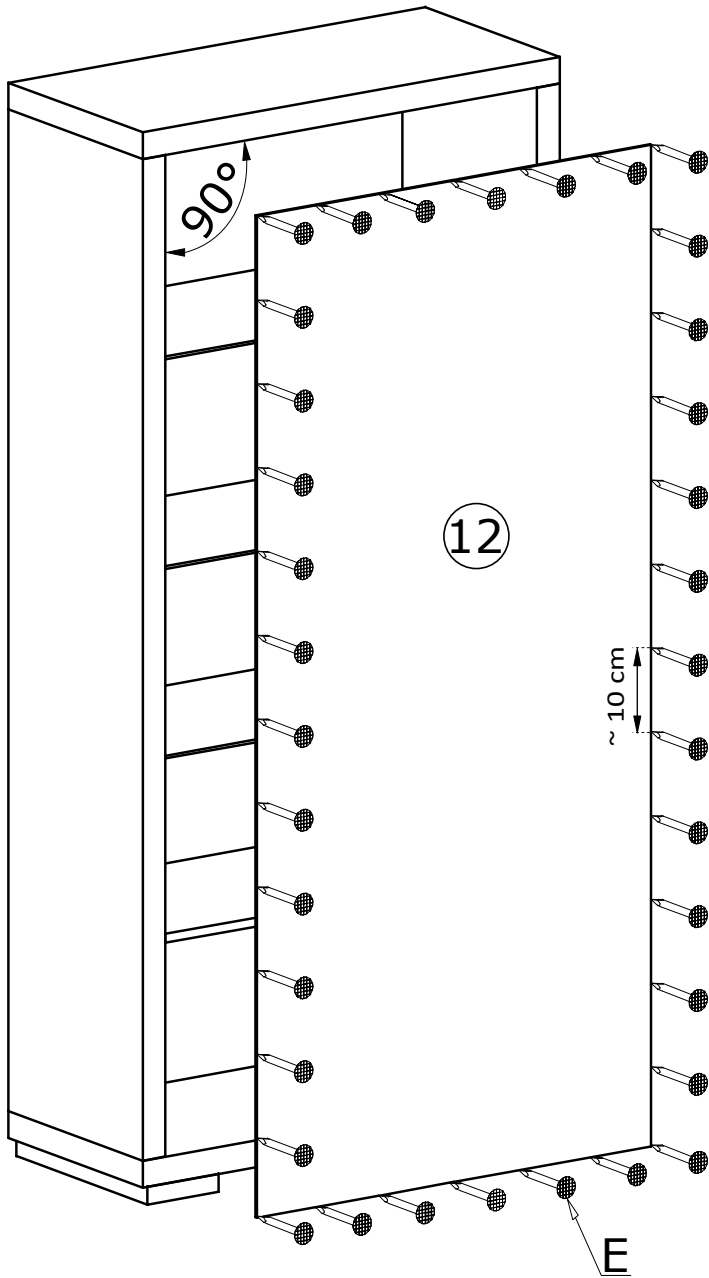

IV

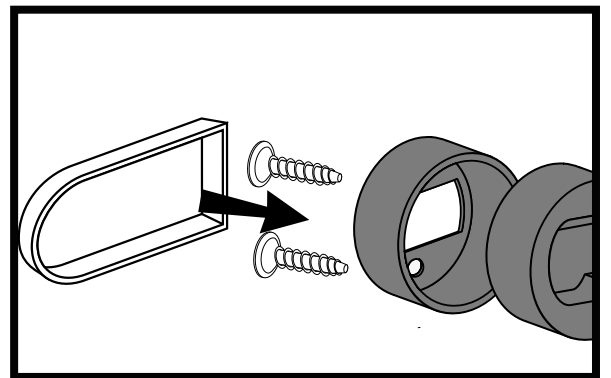
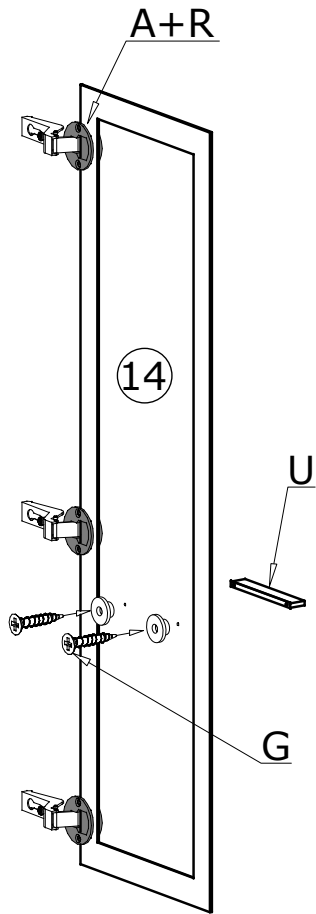
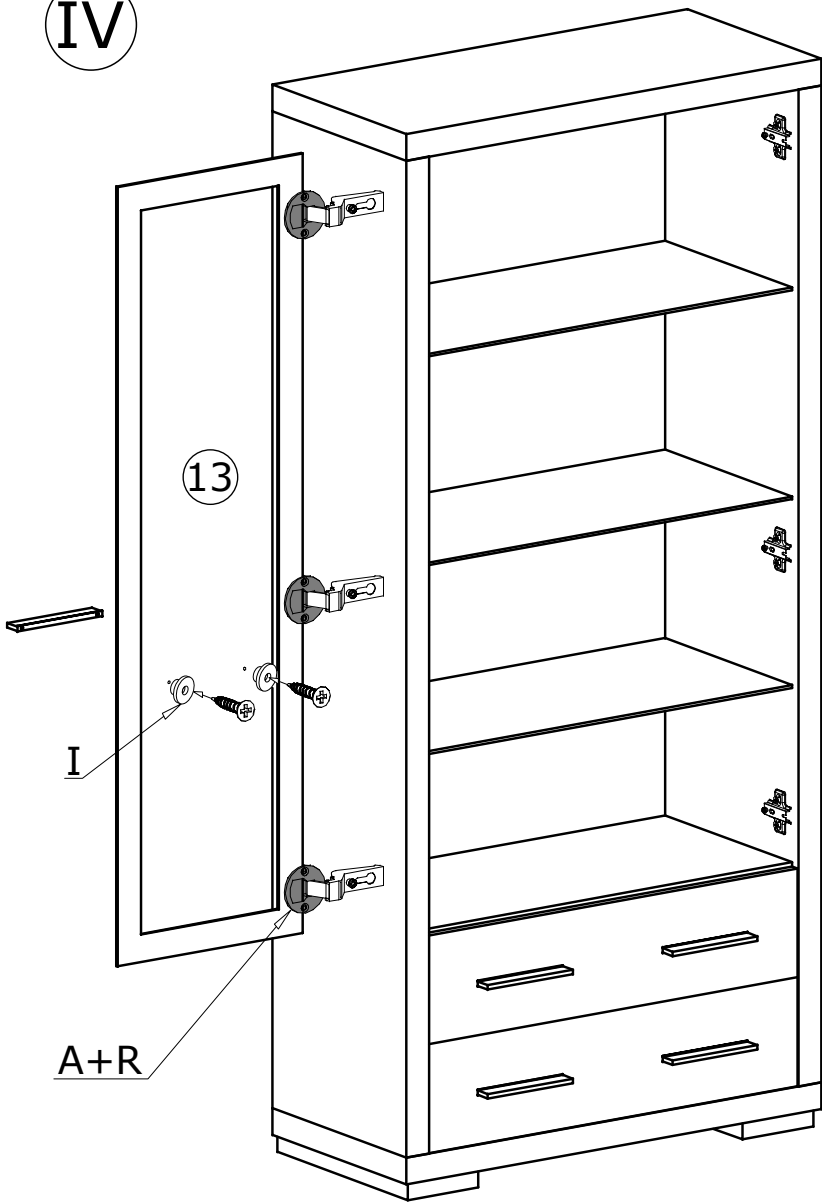

MONTAŻ/DEMONTAŻ PROWADNIC

1



2

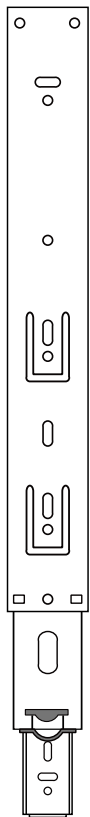

3

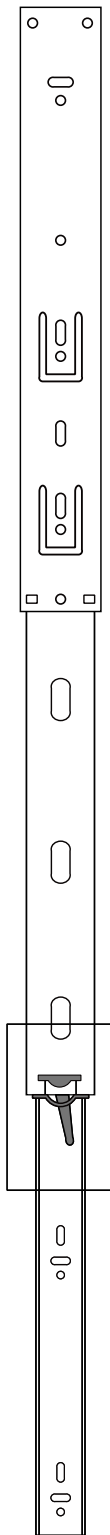

4

