

TADEUSZ 21

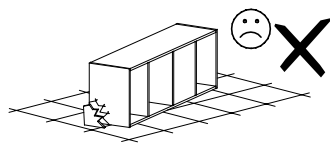

Narzędzia potrzebne do montażu

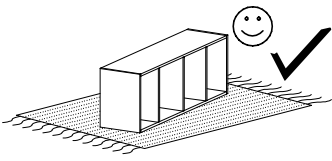
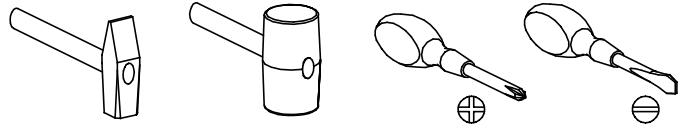

UWAGA !!!

MONTOWANIE USZKODZONYCH
ELEMENTÓW POWODUJE UTRATĘ
GWARANCJI

Nr	D[mm]	S[mm]	G[mm]	Ilość
1	1000	800	32	1
2	1000	500	32	1
3	2000	200	32	1
4	2000	200	32	1
5	900	30	3	1

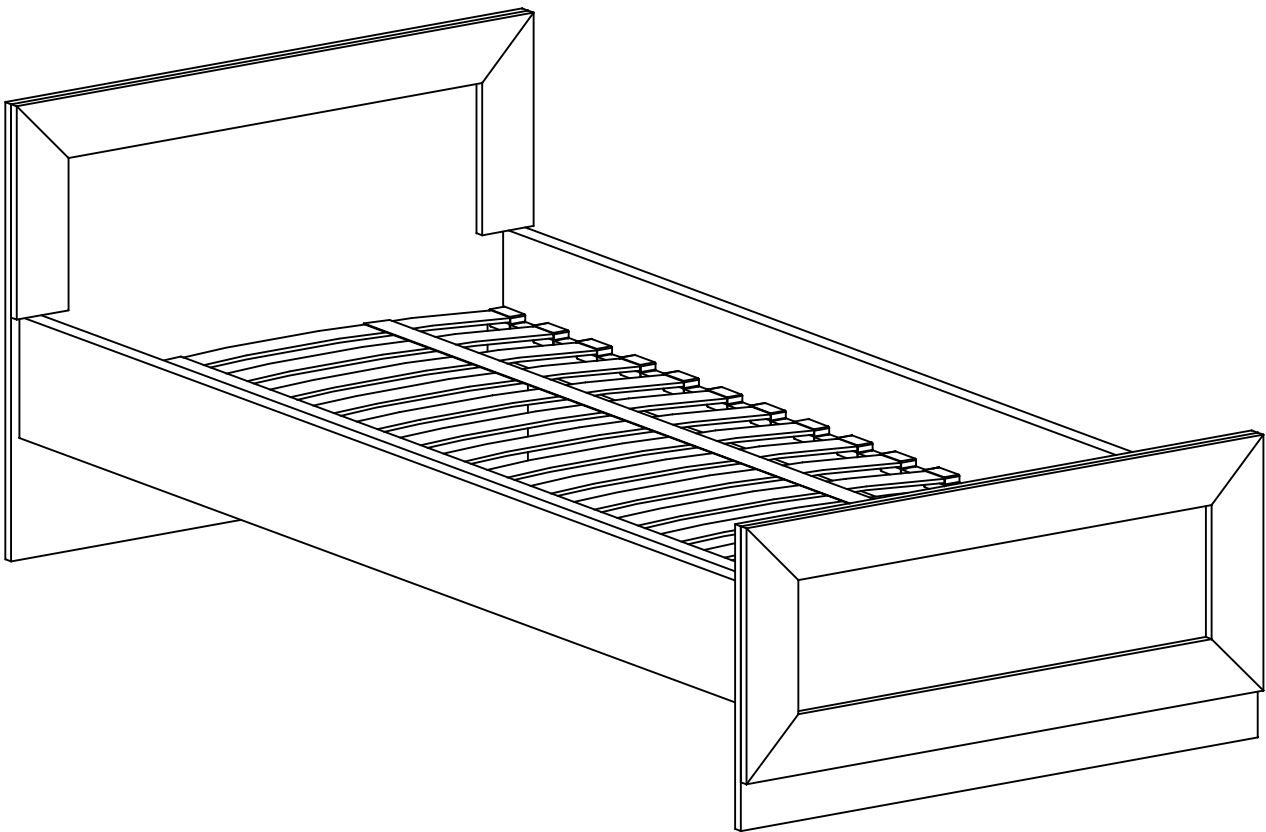

W przypadku reklamacji proszę podać numer pakowacza znajdujący się na kartonie.

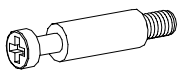

S - 4 St.

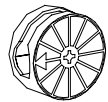

T - 4 St.

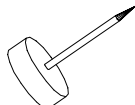

P - 6 St.

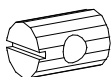

W - 4 St.



B - 8 St.

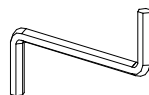

Z - 1 St.



K - 4 St.
4x70 mm

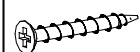

H - 10 St.
3,9x30 mm

