

TADEUSZ 15

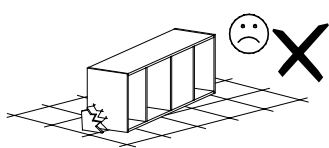

Narzędzia potrzebne do montażu

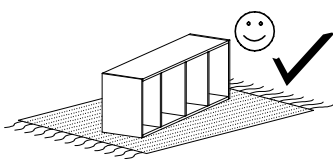
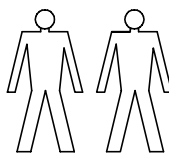
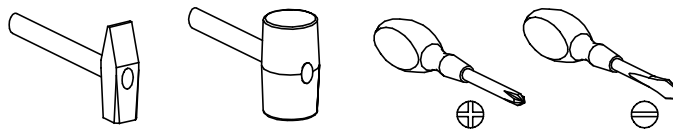

UWAGA !!!

MONTOWANIE USZKODZONYCH
ELEMENTÓW POWODUJE UTRATĘ
GWARANCJI

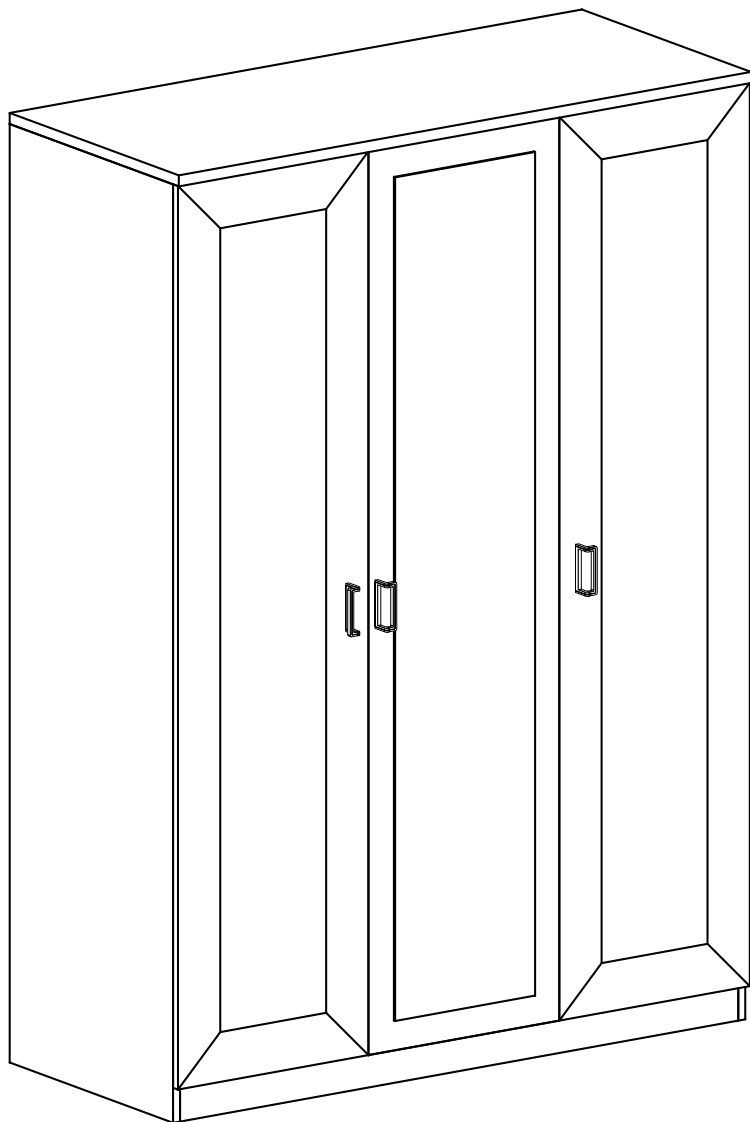

| Nr | D[mm] | S[mm] | G[mm] | Ilość |
|----|-------|-------|-------|-------|
| 1 | 1345 | 570 | 32 | 1 |
| 2 | 1298 | 540 | 16 | 1 |
| 3 | 1775 | 540 | 16 | 1 |
| 4 | 1298 | 80 | 16 | 2 |
| 5 | 510 | 423 | 16 | 4 |
| 6 | 1870 | 540 | 16 | 1 |
| 7 | 1870 | 540 | 16 | 1 |
| 8 | 1800 | 440 | 2,5 | 1 |
| 9 | 1800 | 880 | 2,5 | 1 |
| 10 | 858 | 510 | 16 | 1 |
| 11 | 1780 | 438 | 16 | 1 |
| 12 | 1780 | 438 | 16 | 1 |
| 13 | 1780 | 438 | 16 | 1 |

W przypadku reklamacji proszę podać numer pakowacza znajdujący się na kartonie.

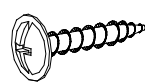

I - 4 St.
3,5x16 mm

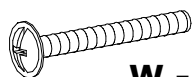

W - 4 St.
4x37 mm



Y - 10 St.

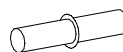

P - 20 St.

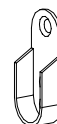

Y - 2 St.

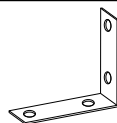

O - 2 St.

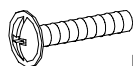

N - 2 St.
4x25 mm



U - 3 St.



G - 32 St.
3,5x16 mm



L - 10 St.

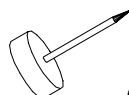

Q - 6 St.



E - 60 St.

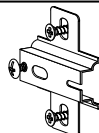

C - 9 St.

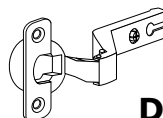

D - 9 St.



S - 1 St.

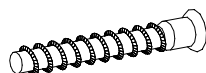

R - 6 St.



B - 20 St.

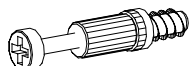

K - 10 St.

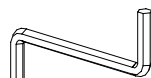

Z - 1 St.



R - 1 St.

I

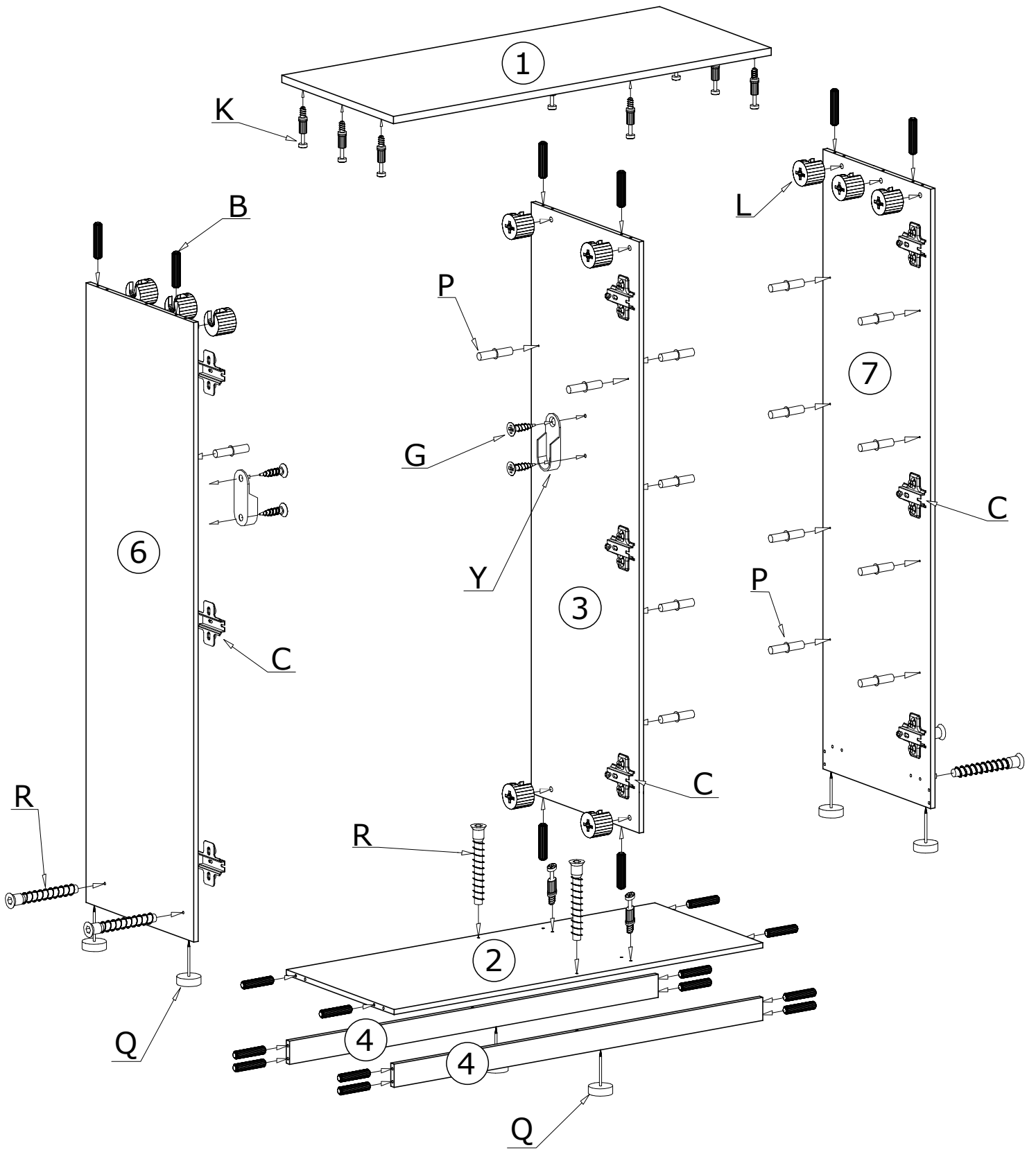

II

60X 

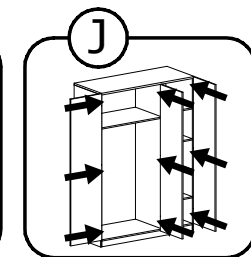
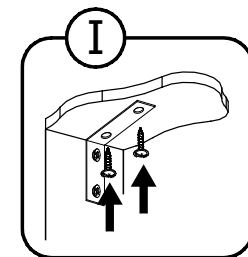
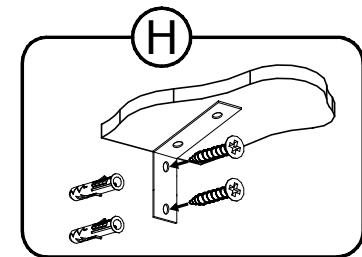
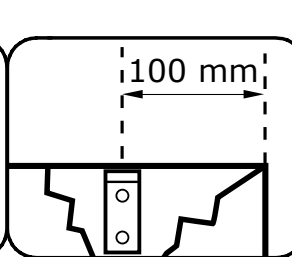
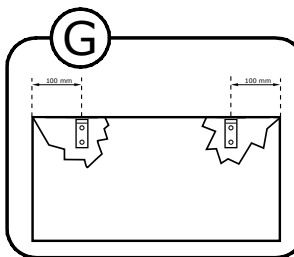
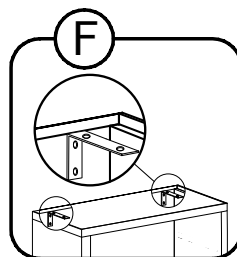
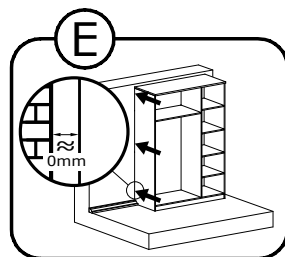
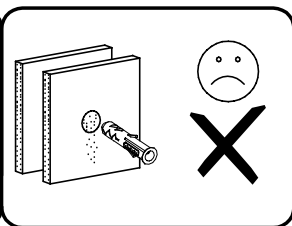
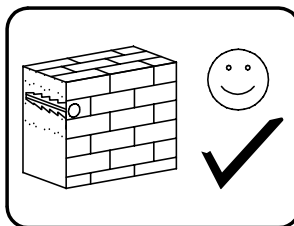
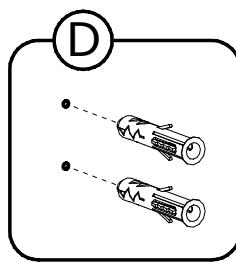
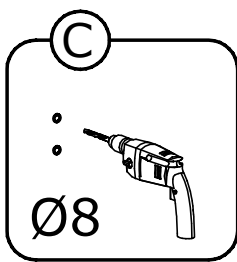
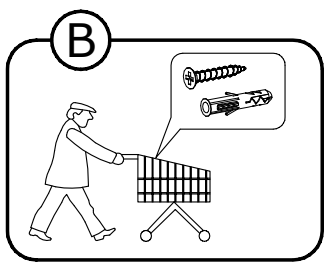
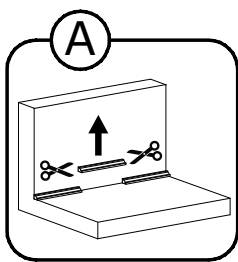
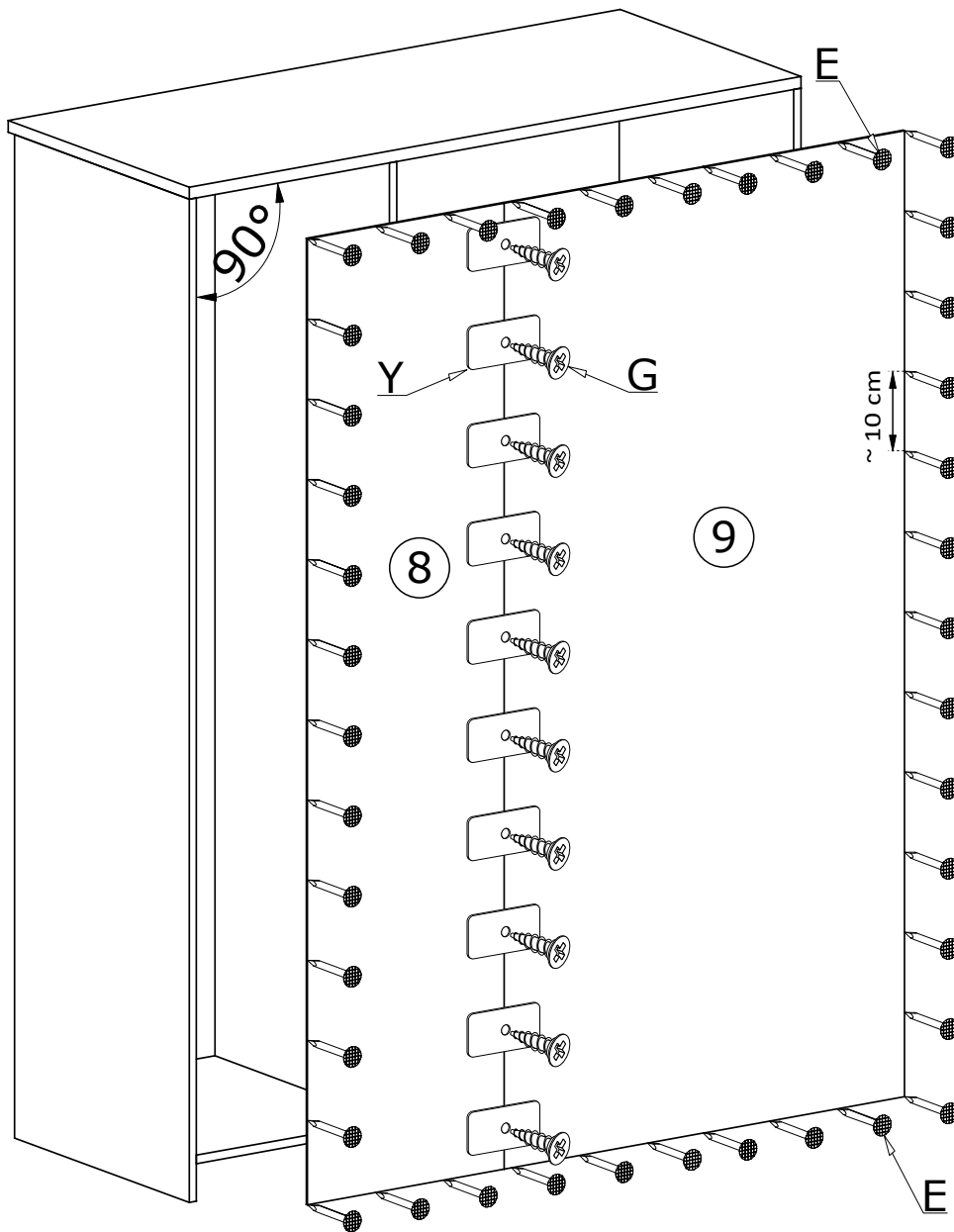

III

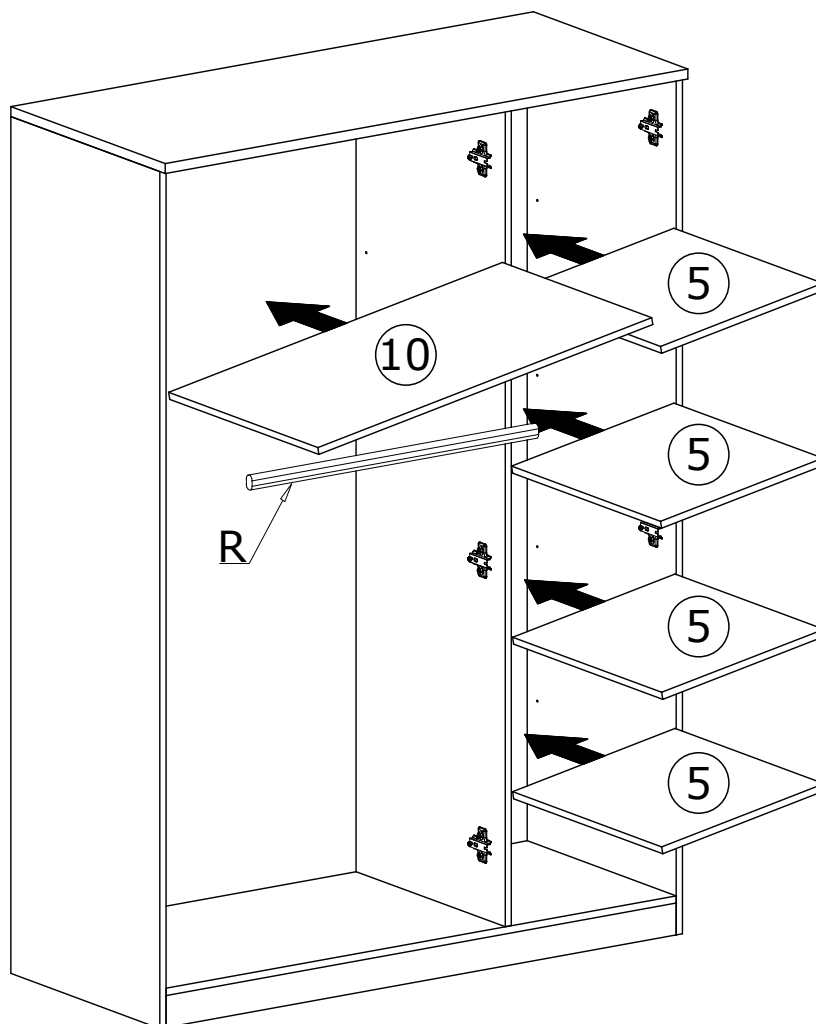

IV

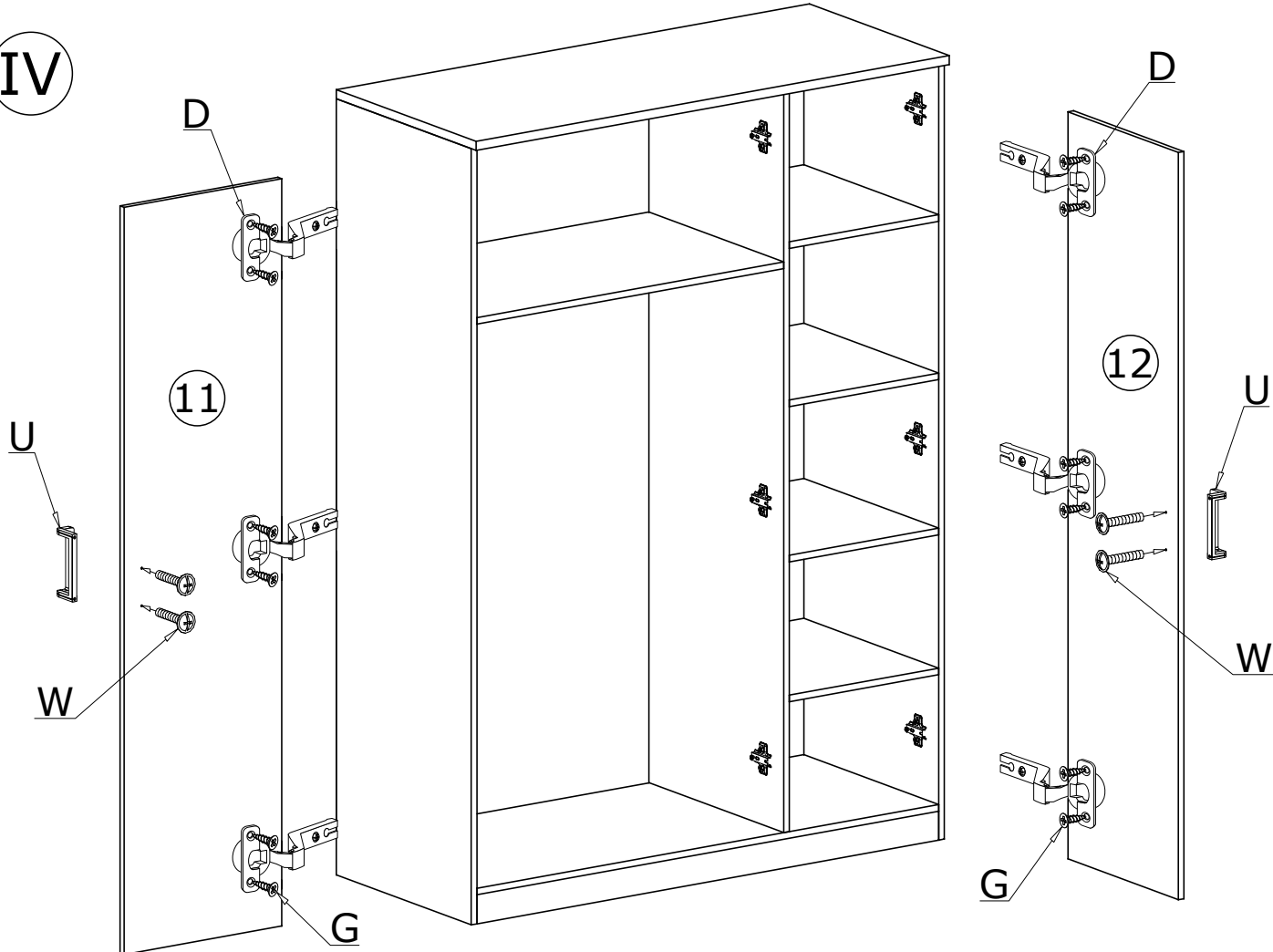

V

