

# TADEUSZ 14

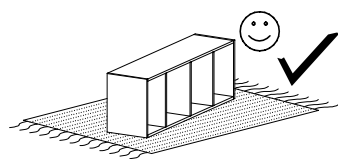

Narzędzia potrzebne do montażu



## UWAGA !!!

MONTOWANIE USZKODZONYCH  
ELEMENTÓW POWODUJE UTRATĘ  
GWARANCJI

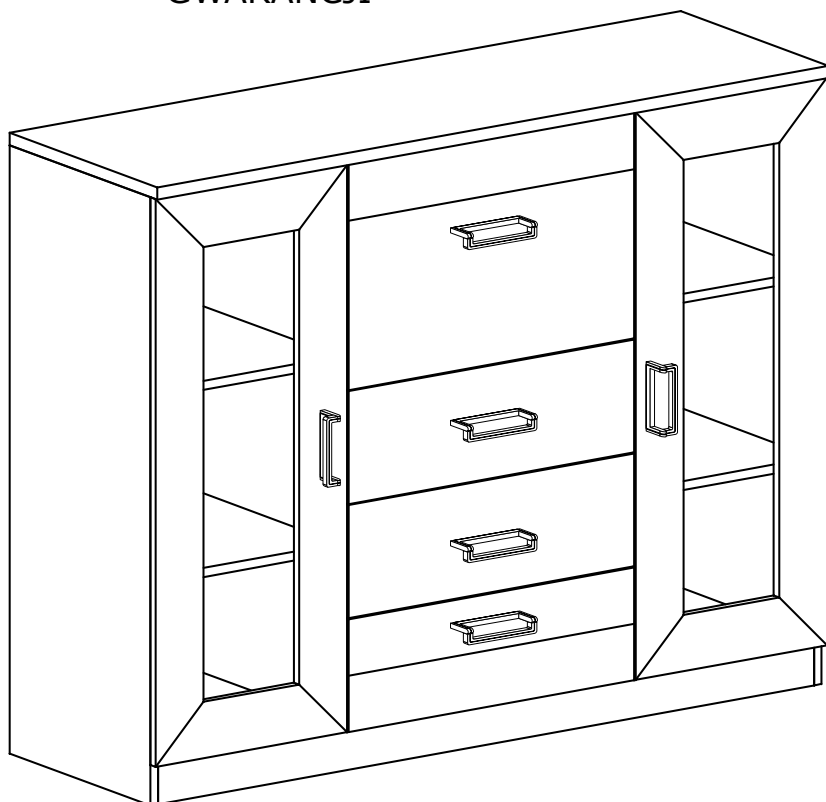

Nr	D[mm]	S[mm]	G[mm]	Ilość
1	1400	440	32	1
2	1352	405	16	1
3	965	405	16	1
4	965	405	16	1
5	1060	405	16	1
6	1060	405	16	1
7	480	405	16	1
8	423	150	16	3
9	400	150	16	3
10	400	150	16	3
11	490	190	16	3
12	453	405	2,5	3
13	1010	500	2,5	1
14	1010	440	2,5	2
15	1352	80	16	1
16	964	438	16	2
17	420	380	16	4
18	490	385	16	1



**X1 - 8 St.**



**X2 - 8 St.**



**X3 - 12 St.**

W przypadku reklamacji proszę podać numer pakowacza znajdujący się na kartonie.

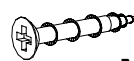

**M - 12 St.**  
3x30 mm



**Y - 12 St.**

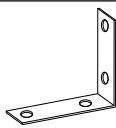

**O - 2 St.**



**I - 4 St.**  
3,5x16 mm

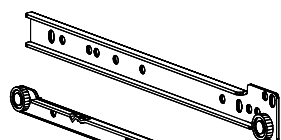

**T - 3 Kpl.**

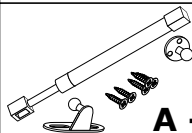

**A - 1 St.**



**U - 6 St.**



**P - 16 St.**

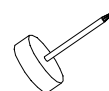

**Q - 6 St.**

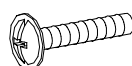

**N - 8 St.**  
4x25 mm

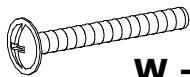

**W - 4 St.**  
4x37 mm



**G - 24 St.**  
3,5x16 mm



**L - 18 St.**

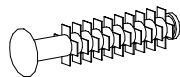

**F - 12 St.**



**E - 120 St.**

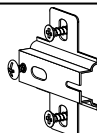

**C - 6 St.**

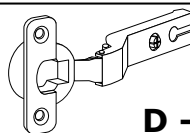

**D - 6 St.**



**S - 1 St.**

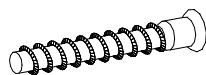

**R - 9 St.**



**B - 32 St.**

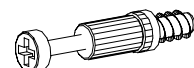

**K - 18 St.**

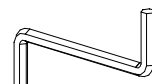

**Z - 1 St.**



**J - 12 St.**  
5x13 mm

I

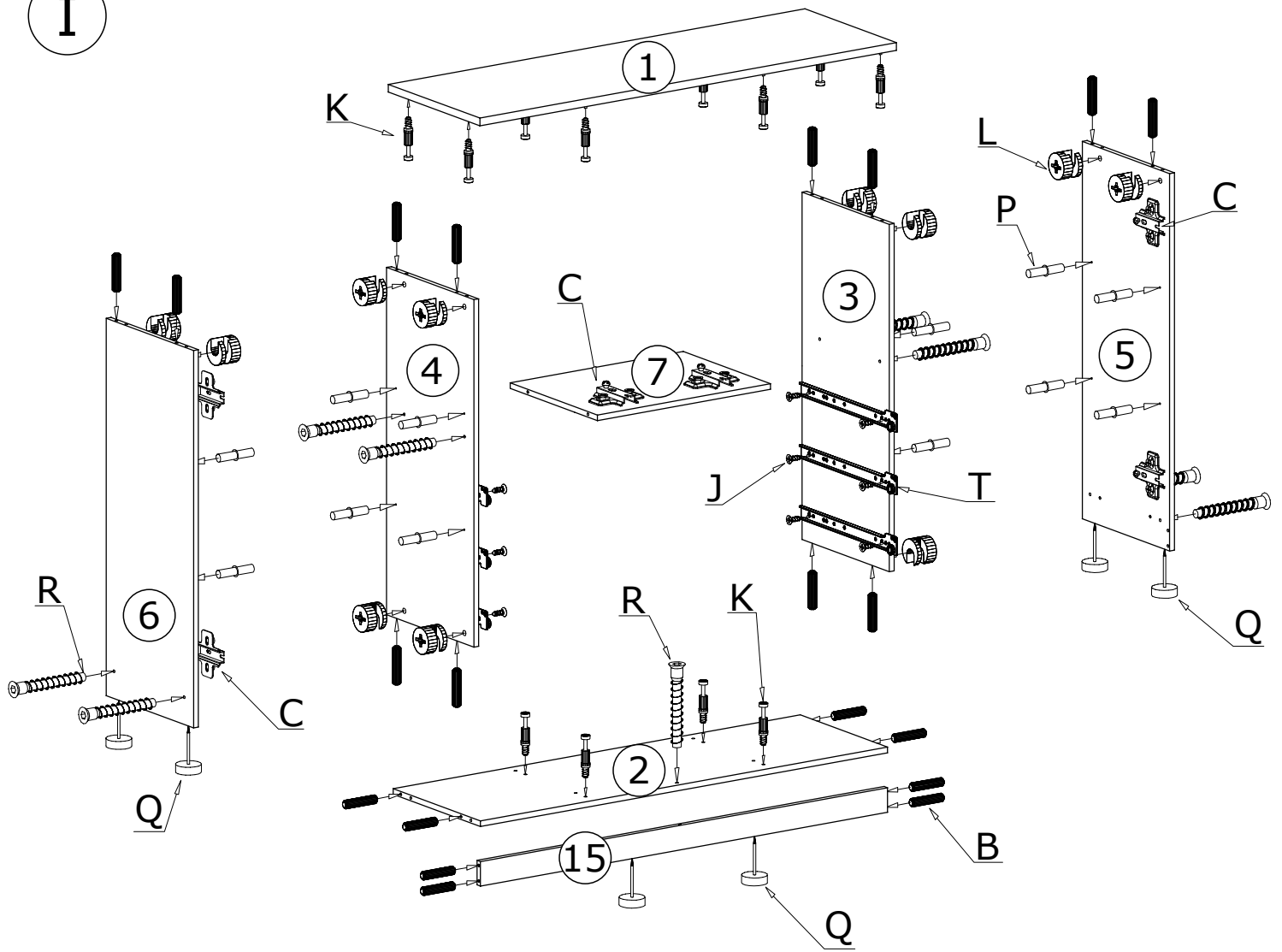

II

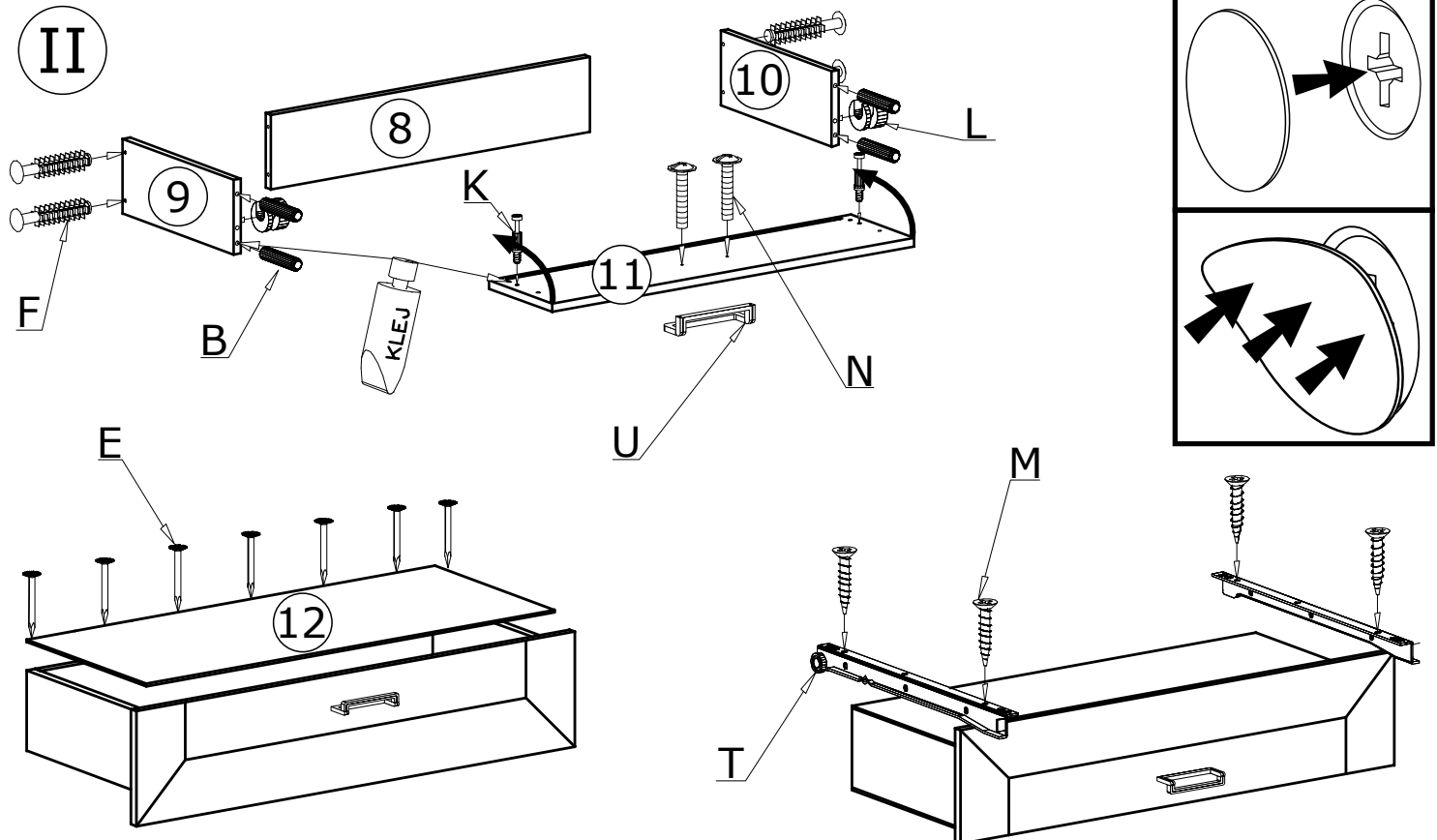

III

120X 

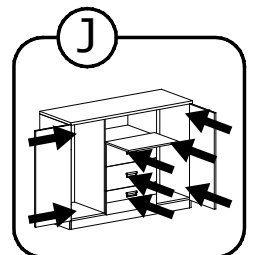
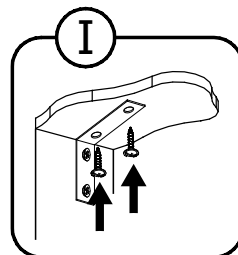
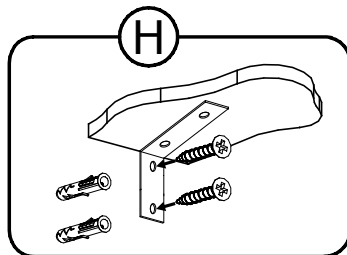
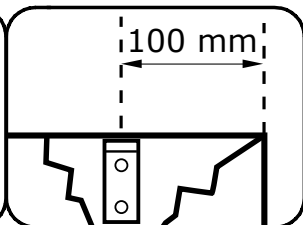
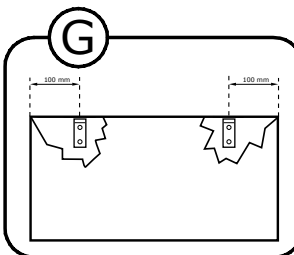
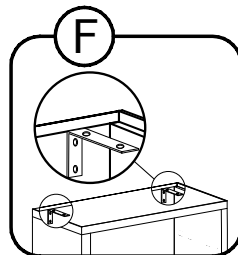
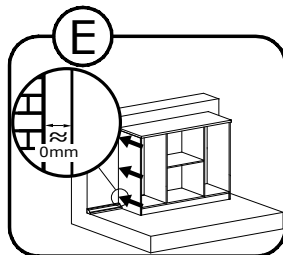
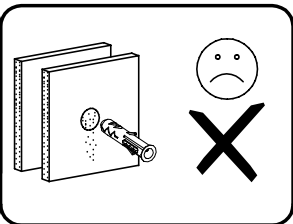
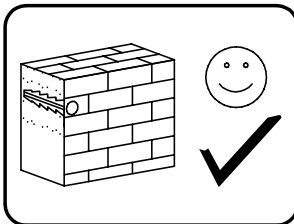
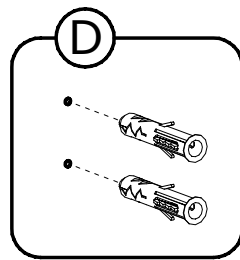
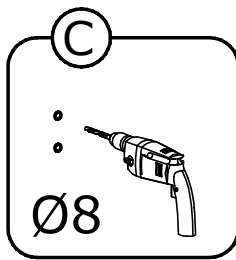
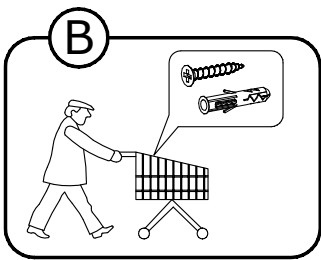
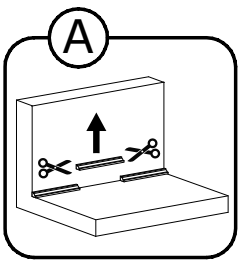
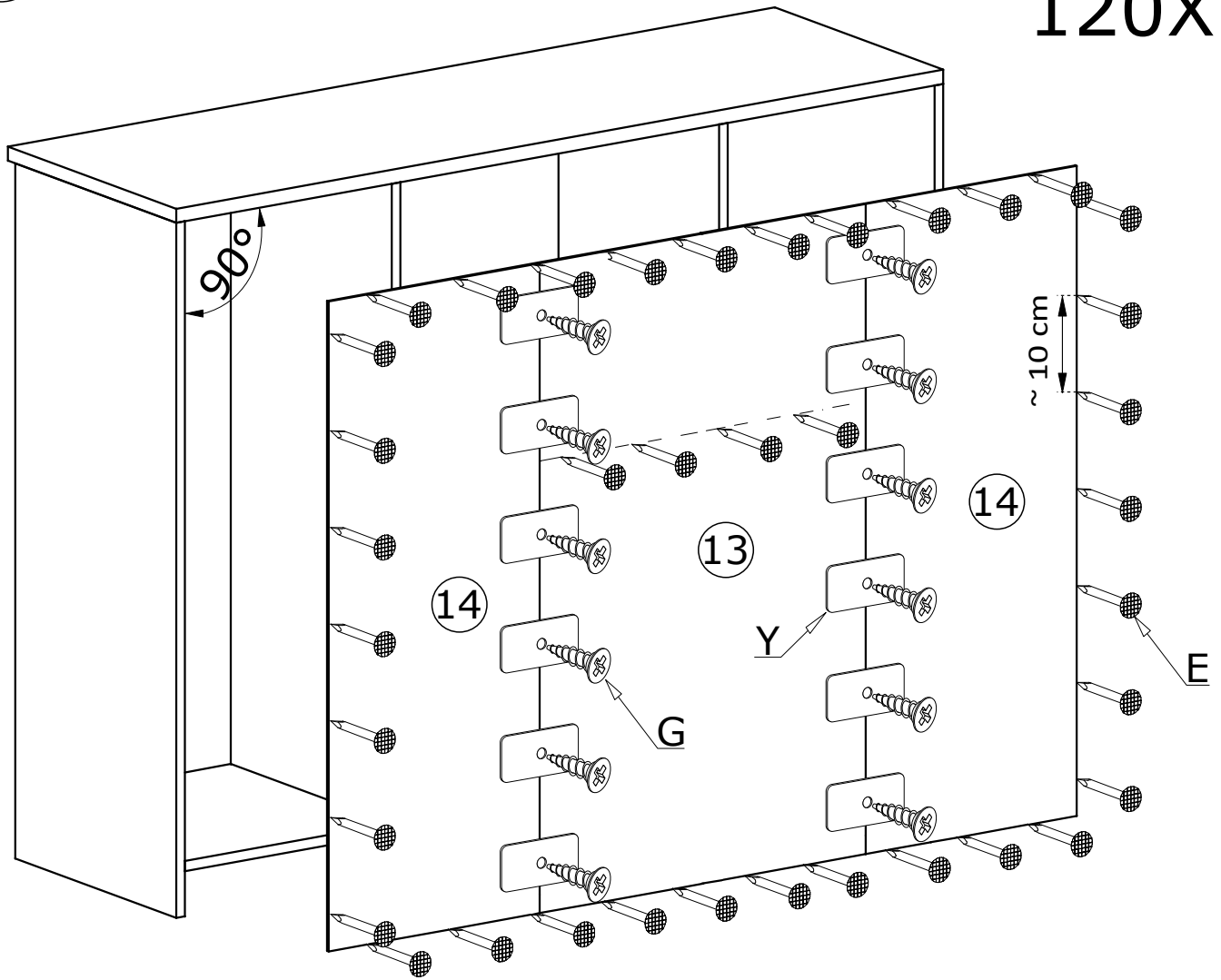

IV

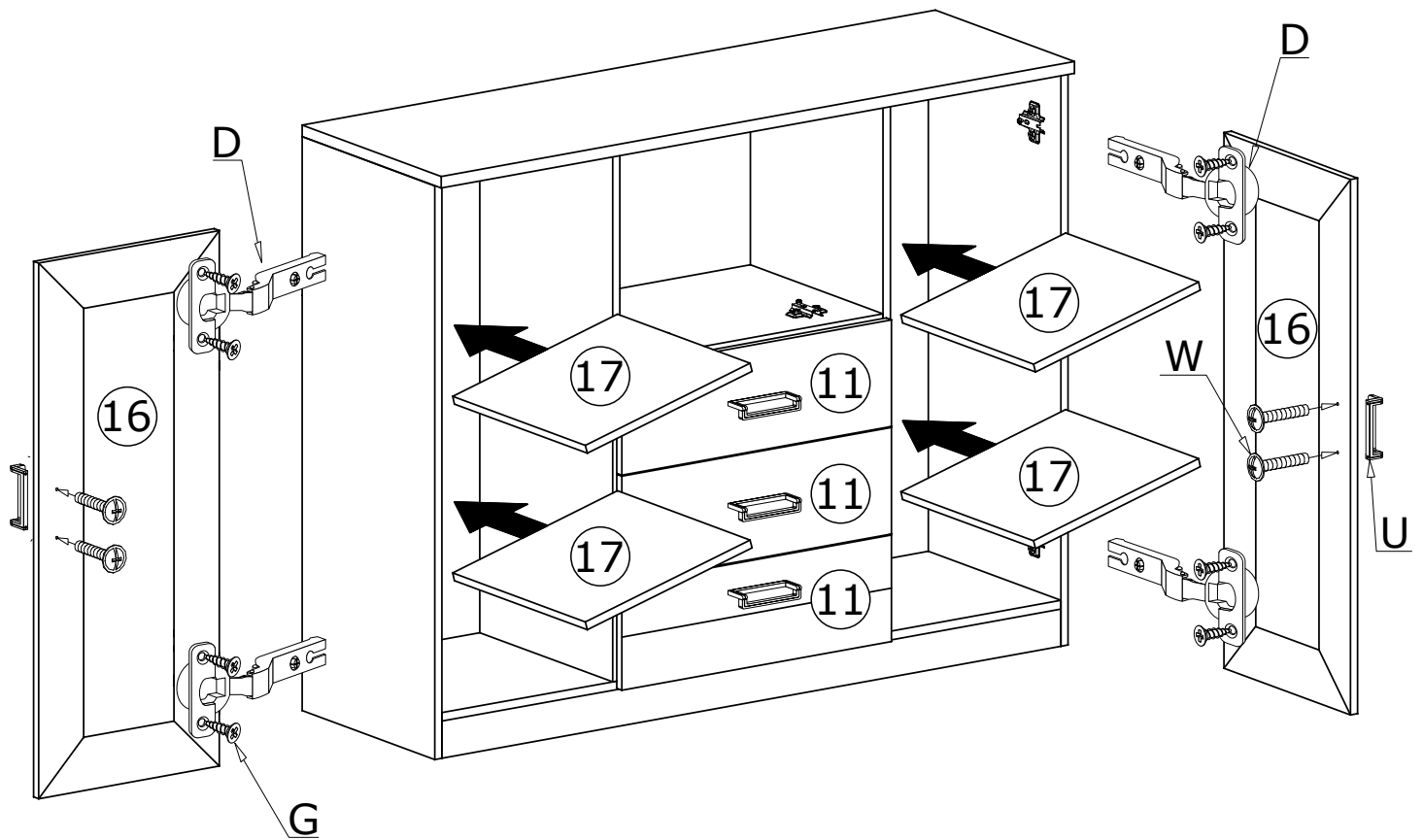

V

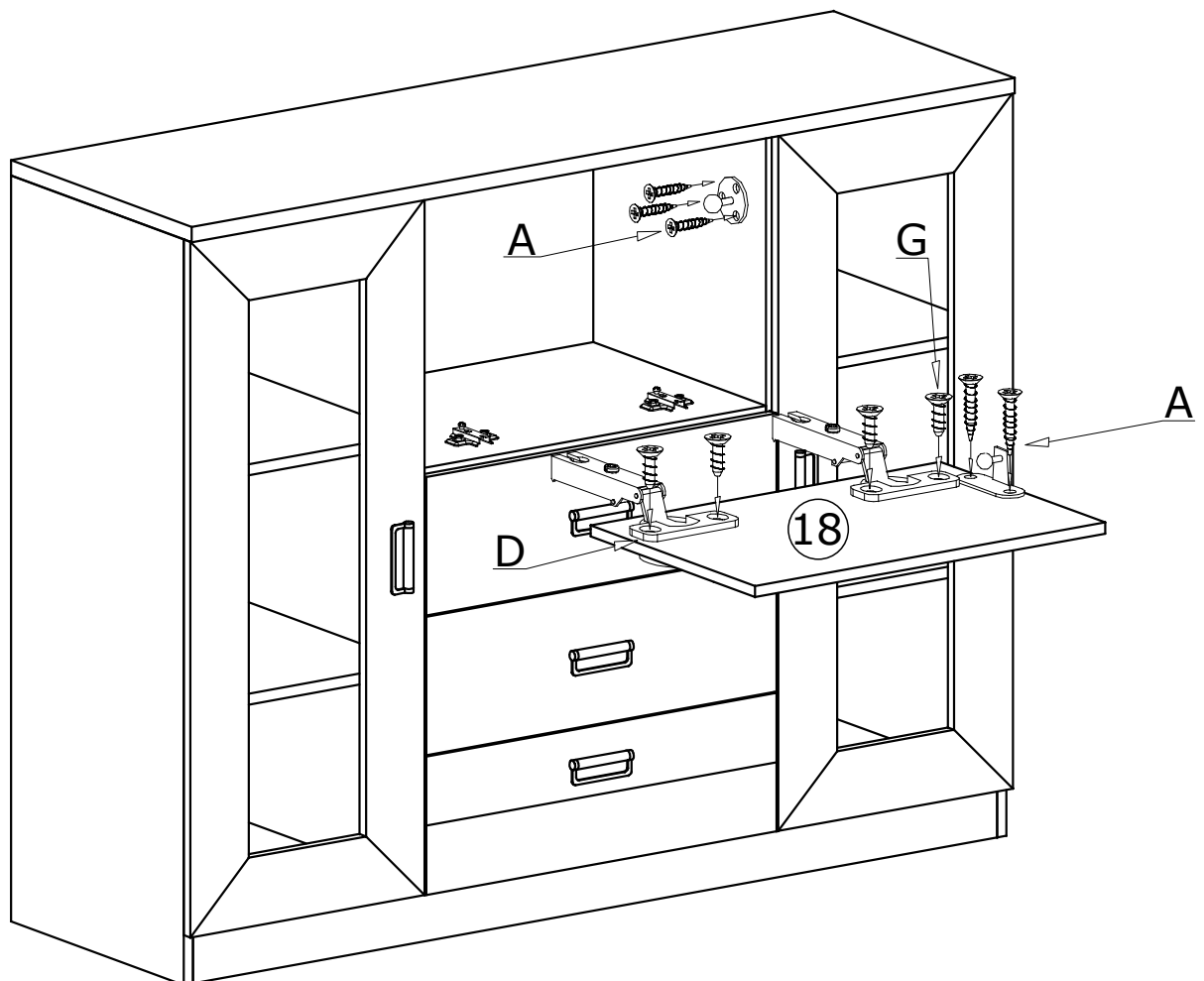

VI

