

TADEUSZ 13

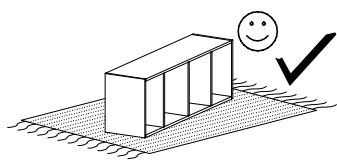

Narzędzia potrzebne do montażu

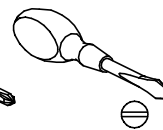
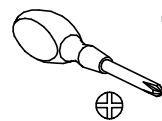
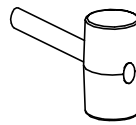
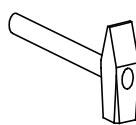

UWAGA !!!

MONTOWANIE USZKODZONYCH
ELEMENTÓW POWODUJE UTRATĘ
GWARANCJI

Nr	D[mm]	S[mm]	G[mm]	Ilość
1	1157	557	16	1
2	1198	598	32	1
3	560	100	16	2
4	560	100	16	2
5	560	85	16	4

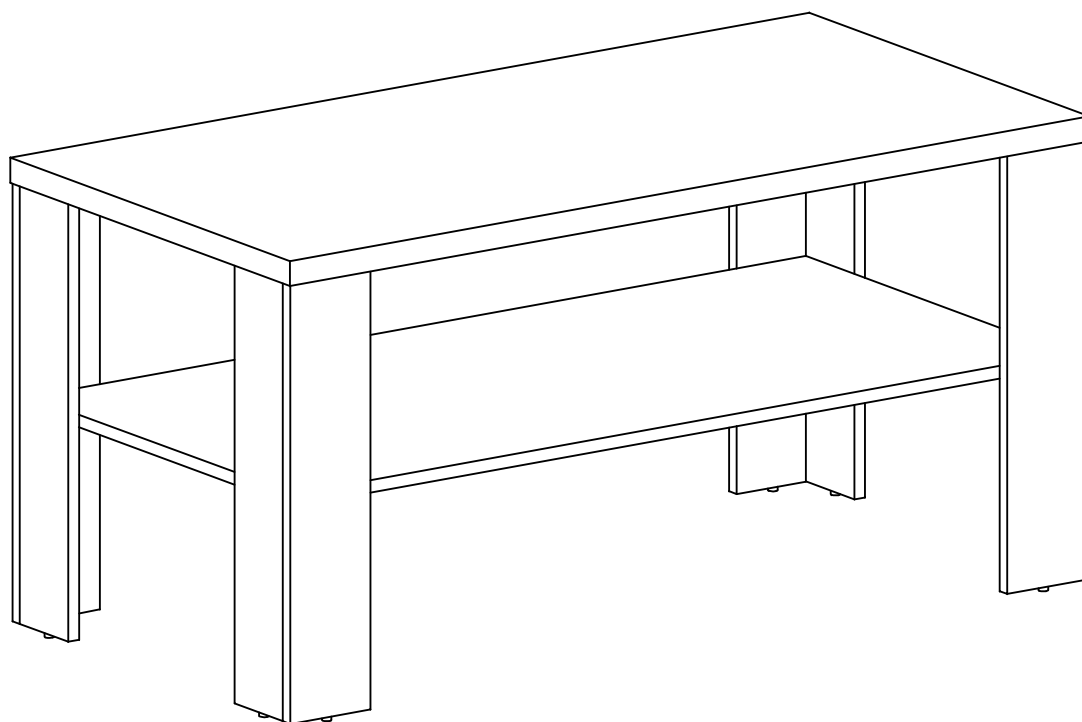

W przypadku reklamacji proszę podać numer pakowacza znajdujący się na kartonie.



L - 12 St.



Q - 8 St.



B - 20 St.

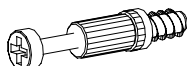

K - 12 St.



Z - 1 St.



S - 2 St.

I

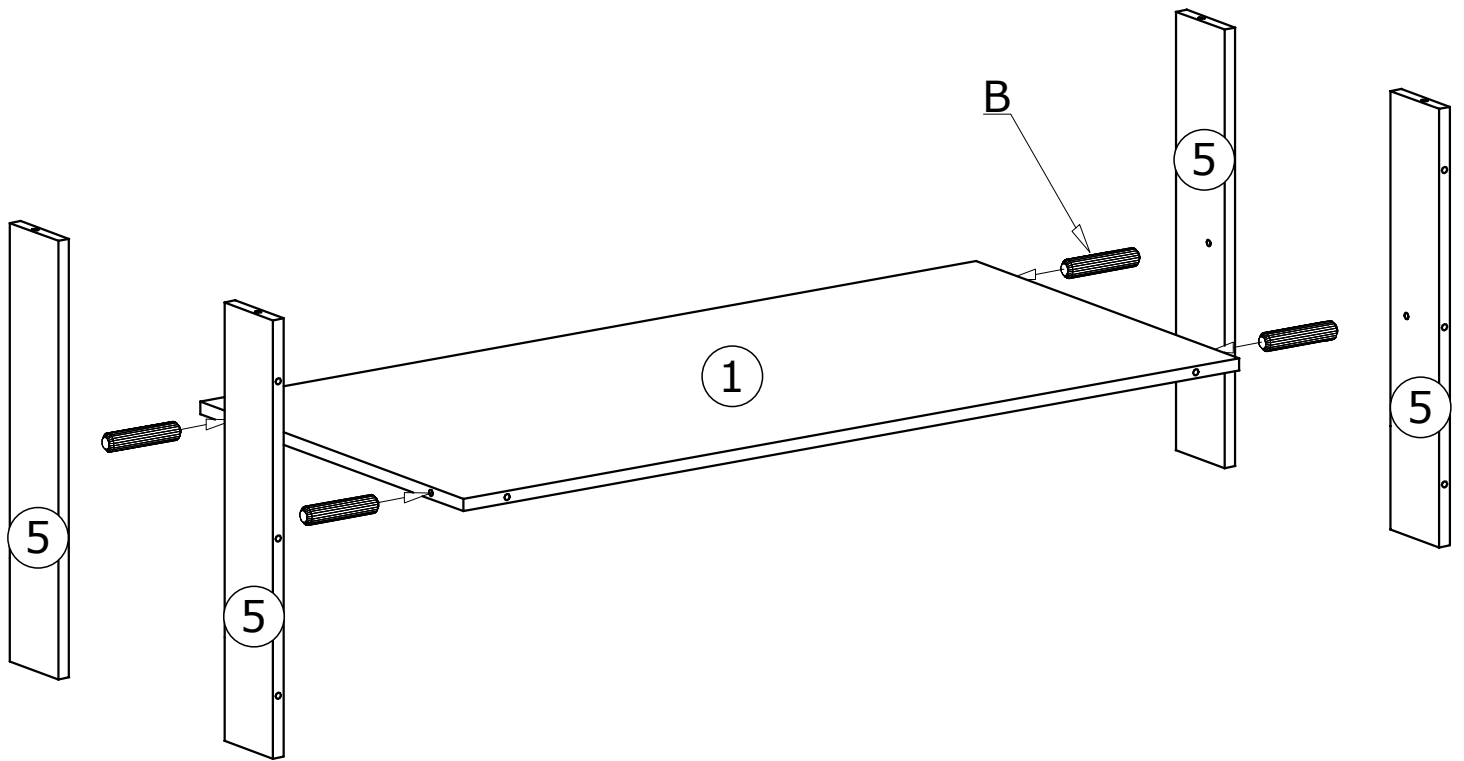

II

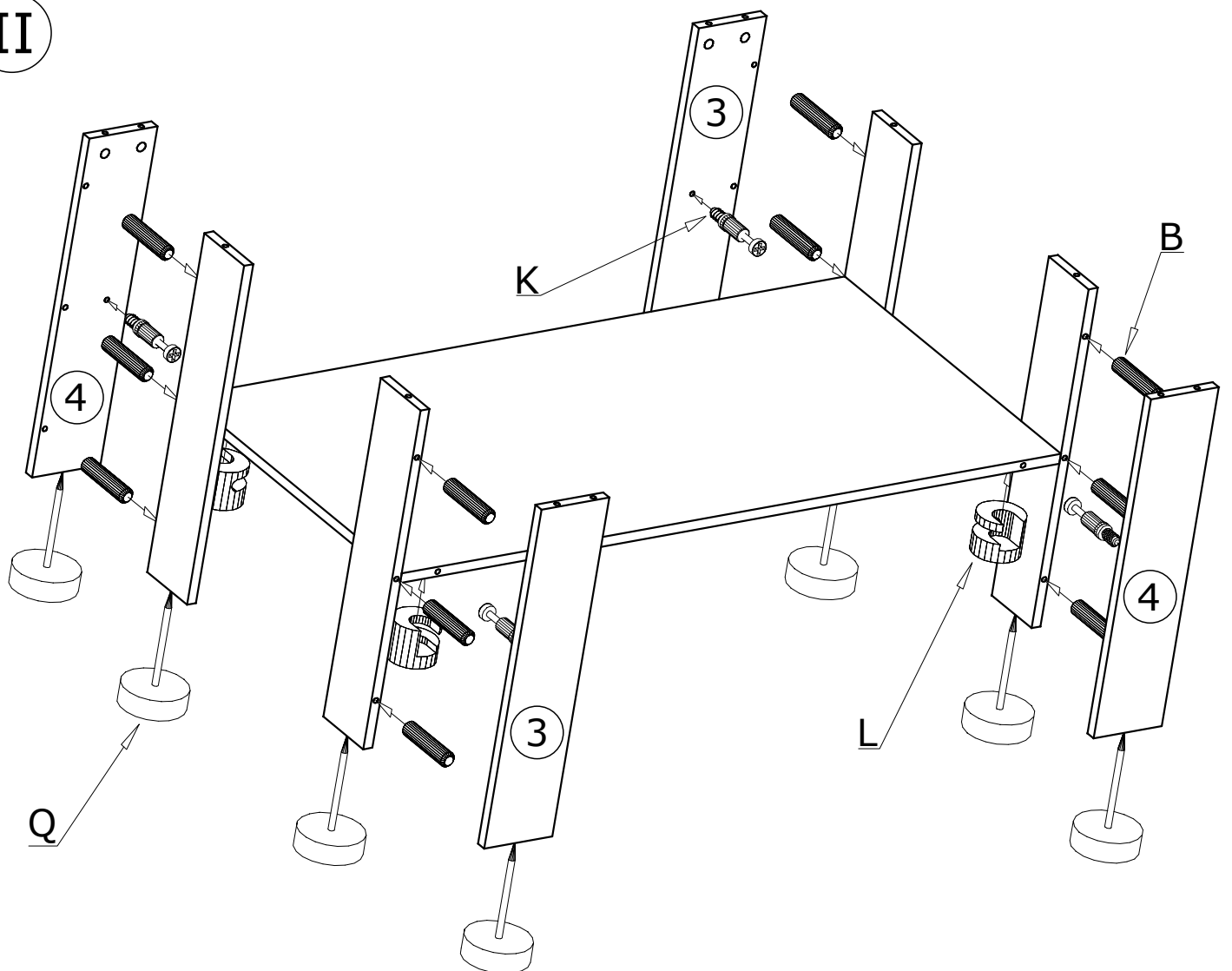

III

