

TADEUSZ 10

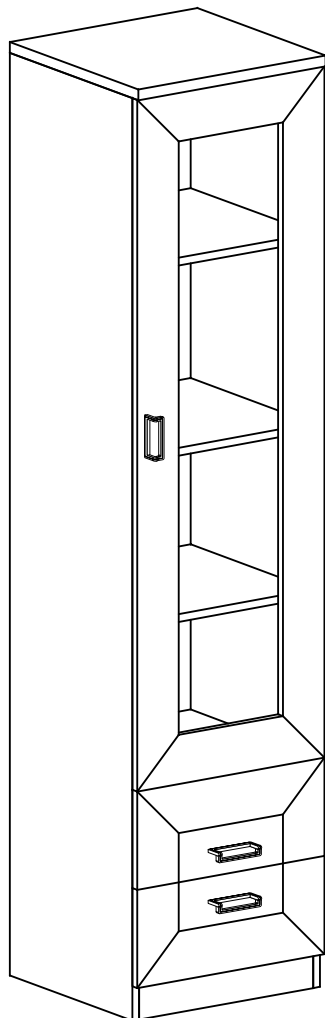

Narzędzia potrzebne do montażu



UWAGA !!!

MONTOWANIE USZKODZONYCH
ELEMENTÓW POWODUJE UTRATĘ
GWARANCJI

| Nr | D[mm] | S[mm] | G[mm] | Ilość |
|----|-------|-------|-------|-------|
| 1 | 460 | 440 | 32 | 1 |
| 2 | 412 | 405 | 16 | 1 |
| 3 | 412 | 405 | 16 | 1 |
| 4 | 412 | 80 | 16 | 1 |
| 5 | 412 | 380 | 16 | 3 |
| 6 | 1870 | 405 | 16 | 1 |
| 7 | 1870 | 405 | 16 | 1 |
| 8 | 1394 | 438 | 16 | 1 |
| 9 | 1800 | 438 | 2,5 | 1 |
| 10 | 440 | 190 | 16 | 2 |
| 11 | 400 | 150 | 16 | 2 |
| 12 | 400 | 150 | 16 | 2 |
| 13 | 355 | 150 | 16 | 2 |
| 14 | 405 | 380 | 2,5 | 2 |

W przypadku reklamacji proszę podać numer pakowacza znajdujący się na kartonie.



X1 - 4 St.

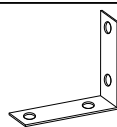

Y - 2 St.

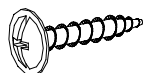

I - 4 St.
3,5x16 mm



X2 - 8 St.



X3 - 10 St.



X4 - 4 St.

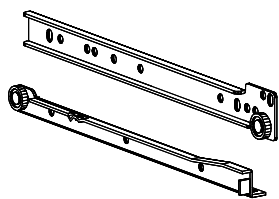

T - 2 Kpl.



M - 8 St.
4x25 mm

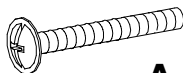

A - 2 St.
4x37 mm



Q - 4 St.



P - 12 St.

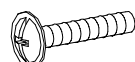

N - 4 St.
4x25 mm



U - 3 St.



G - 6 St.
3,5x16 mm



L - 8 St.

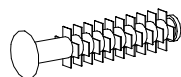

F - 8 St.



E - 50 St.

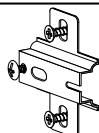

C - 3 St.

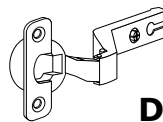

D - 3 St.



S - 1 St.

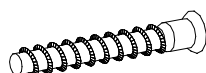

R - 8 St.



B - 24 St.

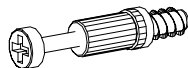

K - 8 St.

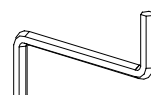

Z - 1 St.



J - 8 St.
5x13 mm

I

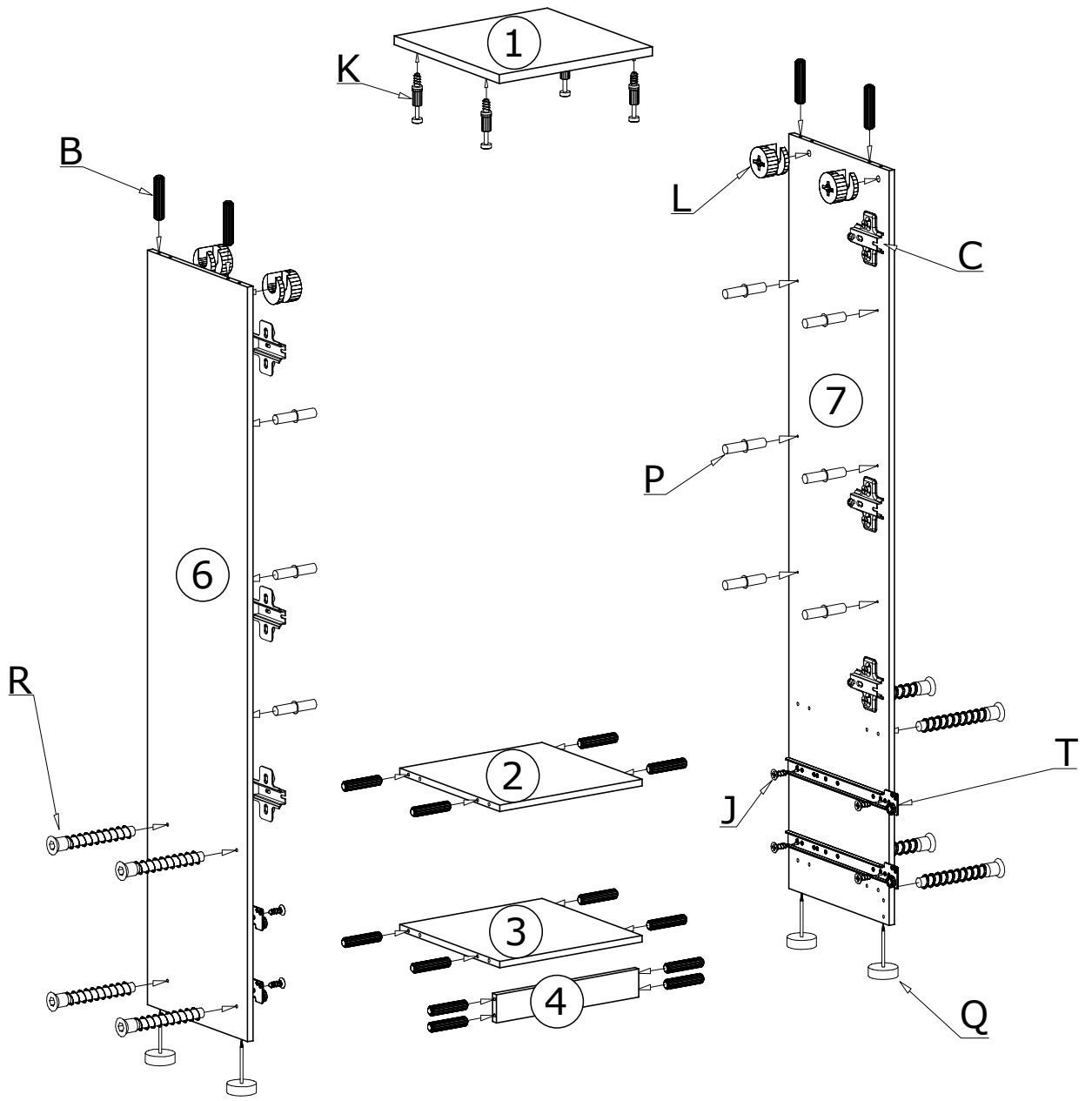

II

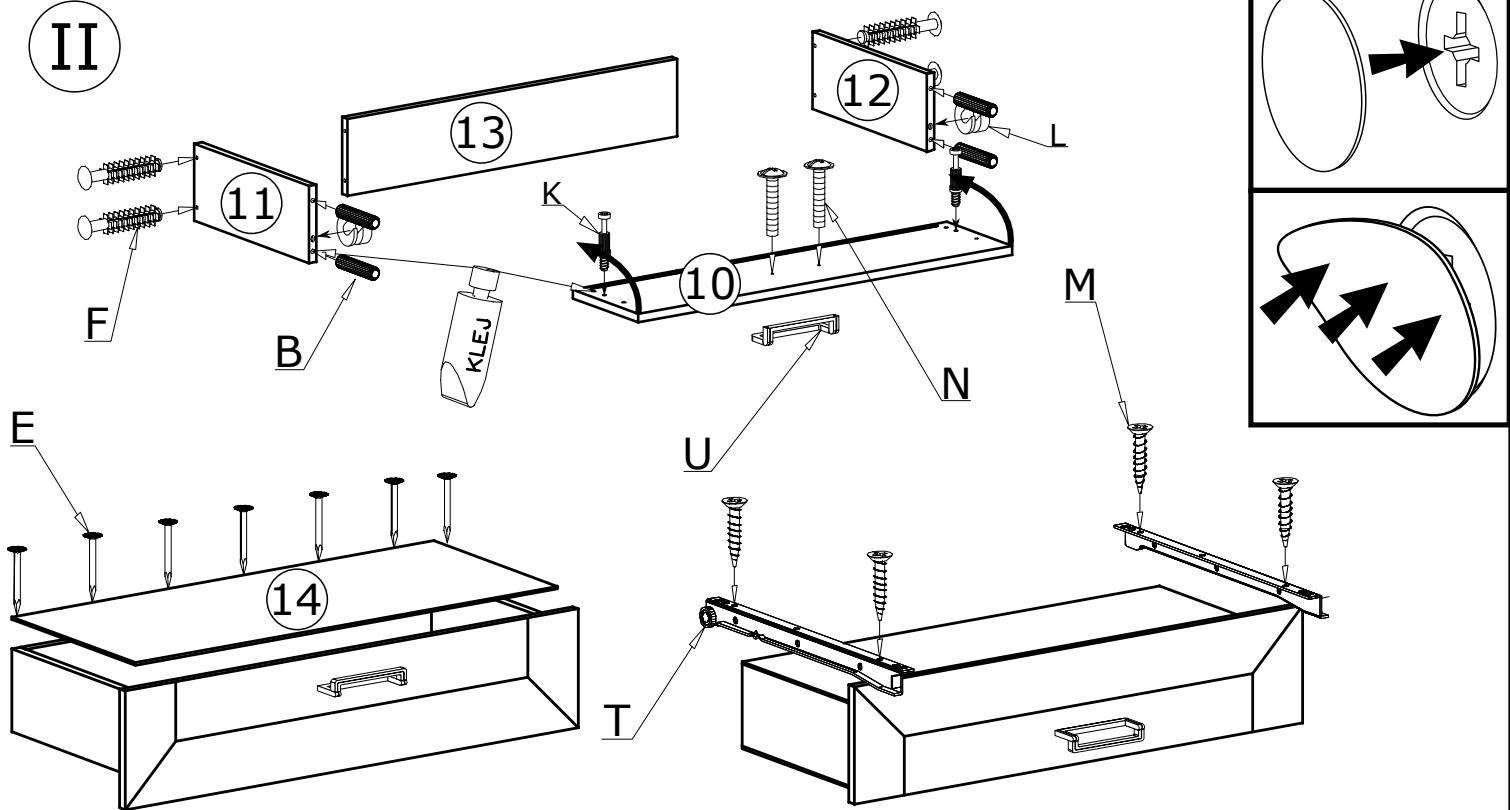

III

50X 

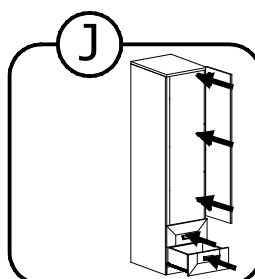
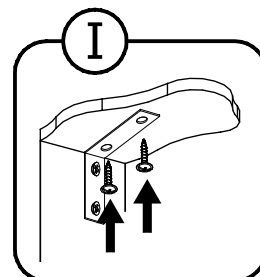
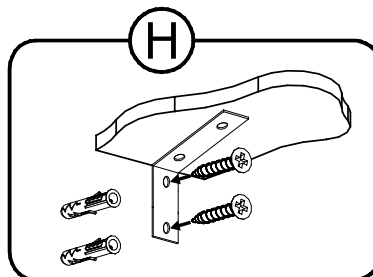
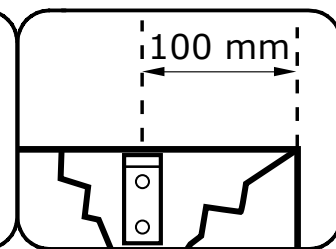
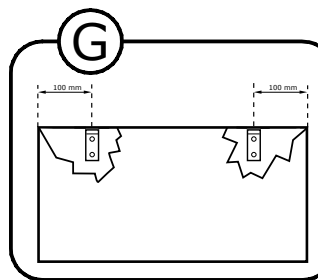
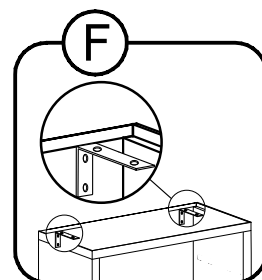
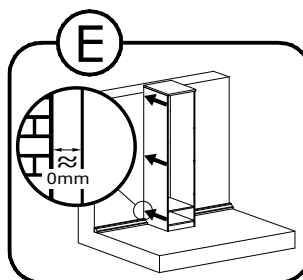
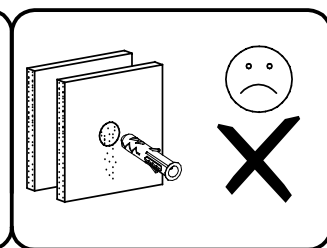
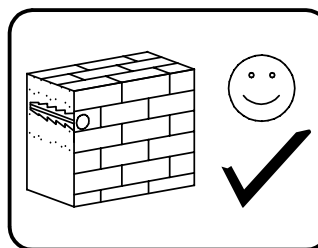
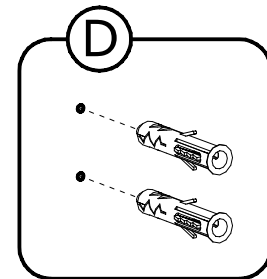
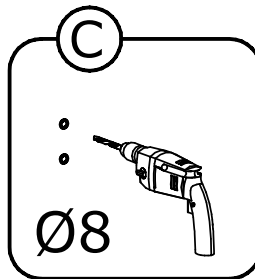
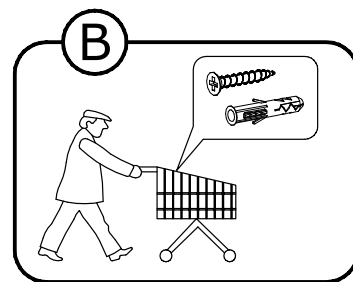
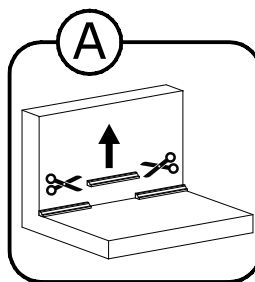
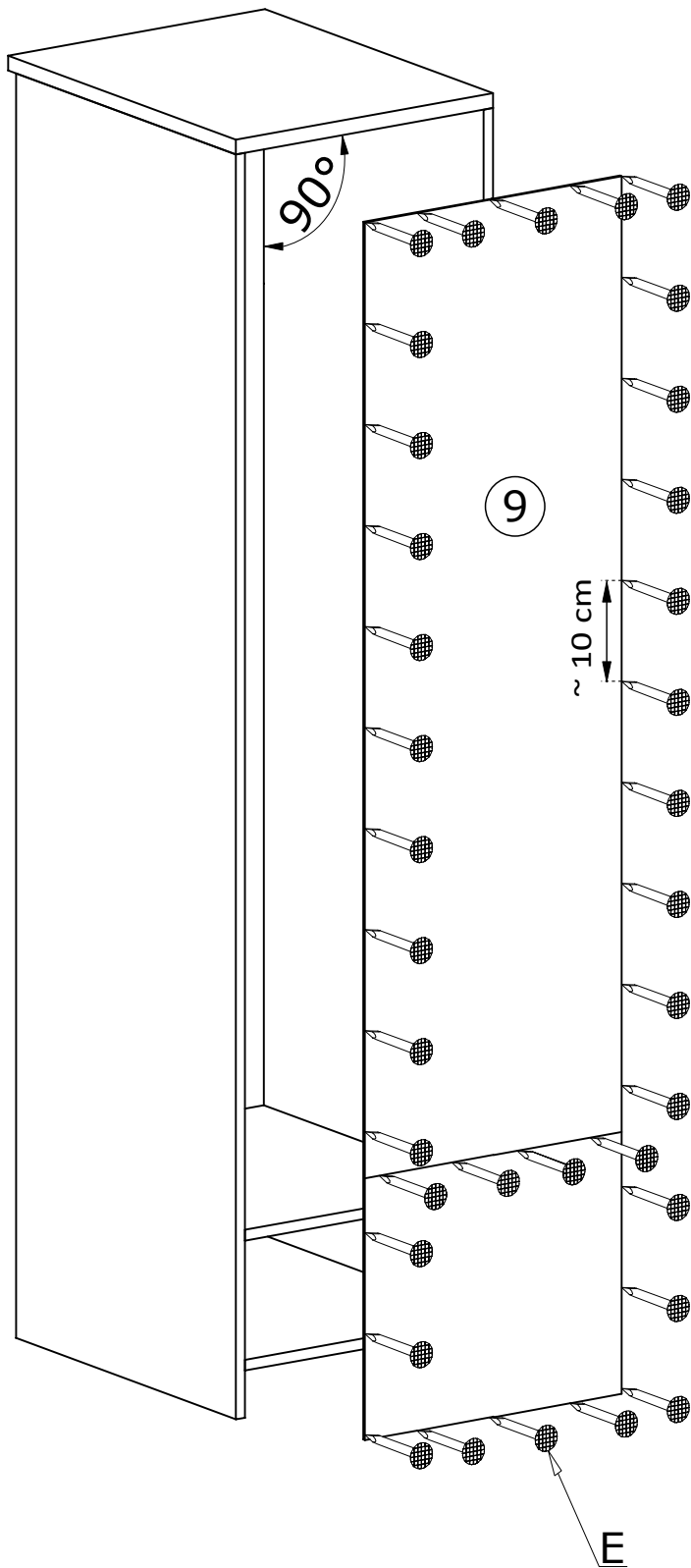

IV

