

# TADEUSZ 9

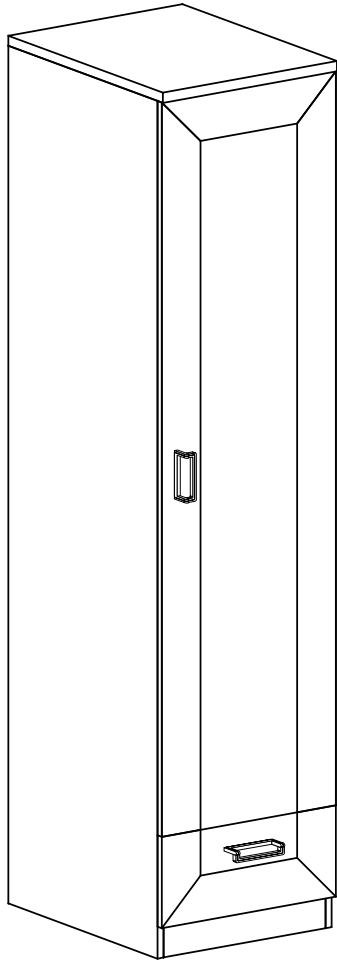

Narzędzia potrzebne do montażu



Nr	D[mm]	S[mm]	G[mm]	Ilość
1	575	460	32	1
2	540	412	16	1
3	540	412	16	1
4	412	80	16	1
5	540	412	16	3
6	1872	540	16	1
7	1872	540	16	1
8	1585	438	16	1
9	1800	437	2,5	1
10	440	190	16	1
11	500	150	16	1
12	500	150	16	1
13	355	150	16	1
14	505	384	2,5	1

**UWAGA !!!**  
MONTOWANIE USZKODZONYCH  
ELEMENTÓW POWODUJE UTRATĘ  
GWARANCJI

W przypadku reklamacji proszę podać numer pakowacza znajdujący się na kartonie.

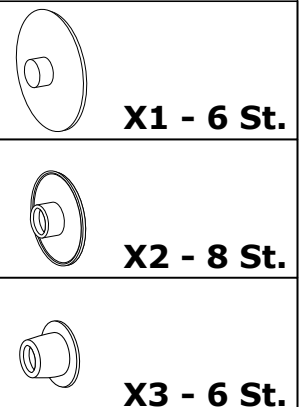

<b>Y - 2 St.</b>	<b>I - 4 St.</b> 3,5x16 mm	<b>M - 4 St.</b> 4x25 mm	<b>P - 12 St.</b>	<b>X4 - 2 St.</b>
<b>T - 1 Kpl.</b>	<b>N2 - 2 St.</b> 4x37 mm	<b>R - 1 St.</b>	<b>Q - 4 St.</b>	<b>Y - 2 St.</b>
	<b>N1 - 1 St.</b> 4x25 mm	<b>U - 2 St.</b>	<b>G - 10 St.</b> 3,5x16 mm	<b>L - 8 St.</b>
<b>F - 4 St.</b>	<b>E - 60 St.</b>	<b>C - 3 St.</b>	<b>D - 3 St.</b>	<b>S - 1 St.</b> KLEJ
<b>A - 8 St.</b>	<b>B - 20 St.</b>	<b>K - 8 St.</b>	<b>Z - 1 St.</b>	<b>J - 4 St.</b> 5x13 mm



III

60X 

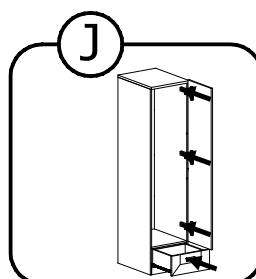
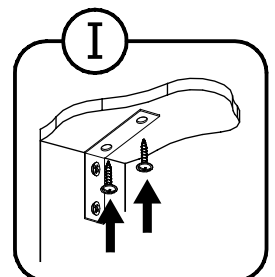
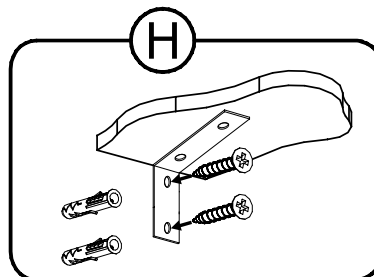
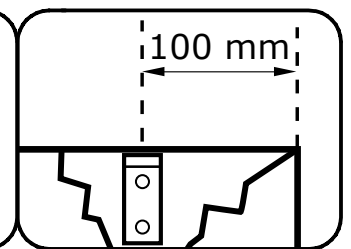
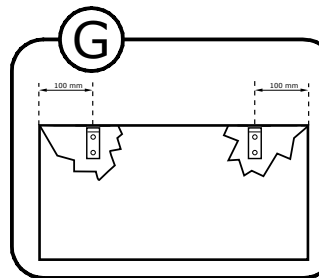
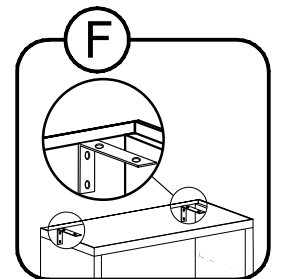
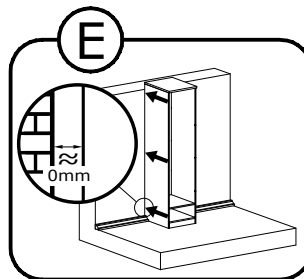
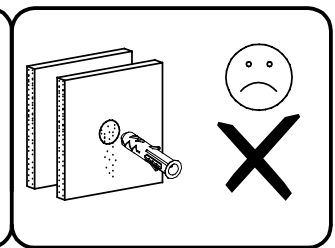
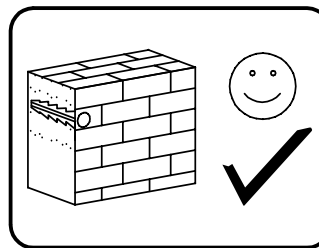
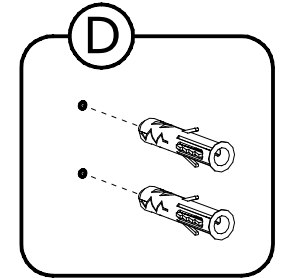
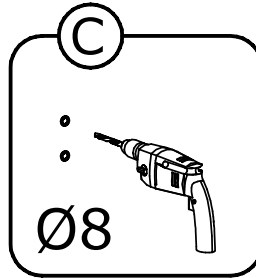
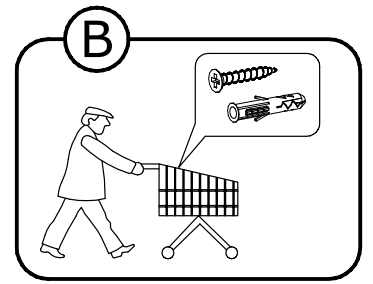
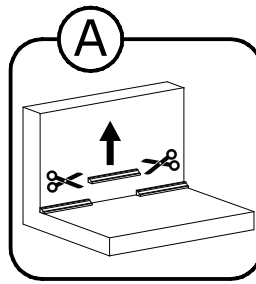
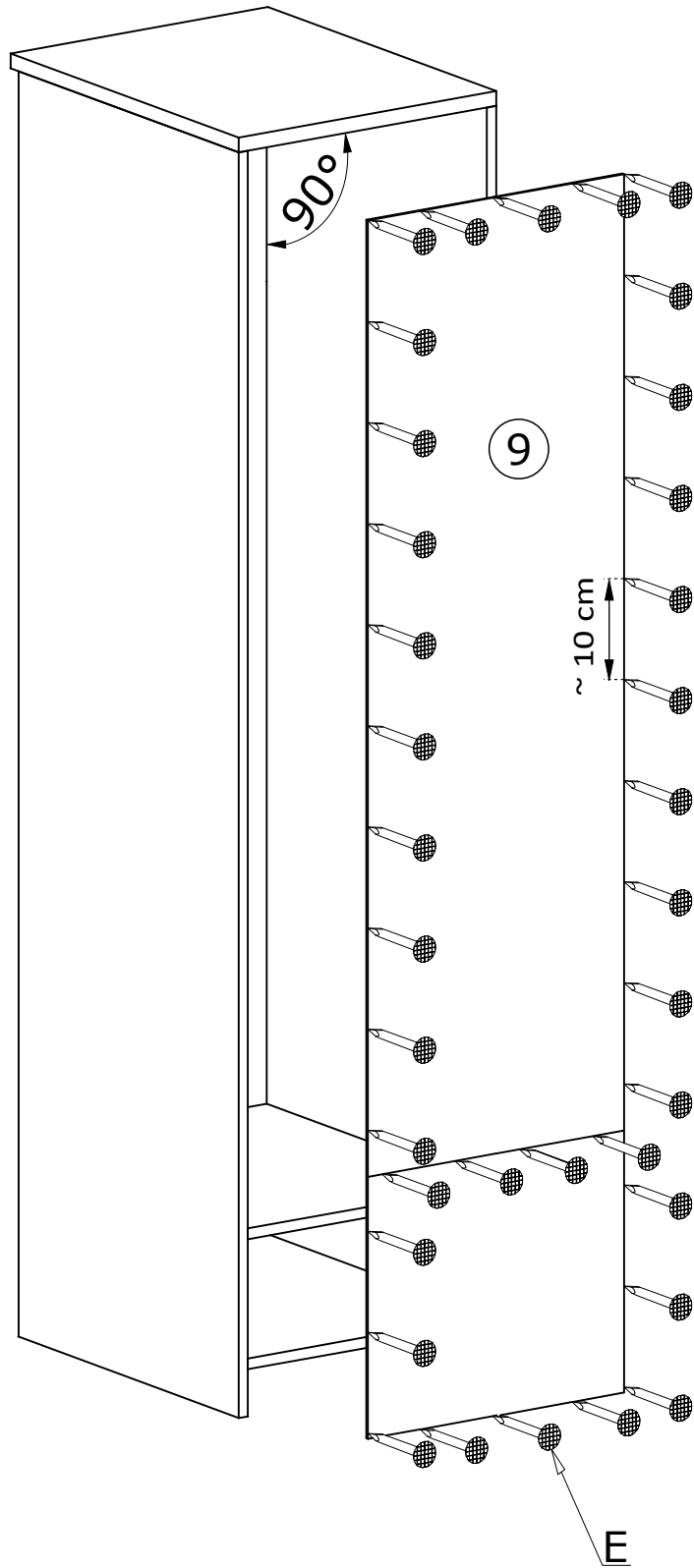

IV

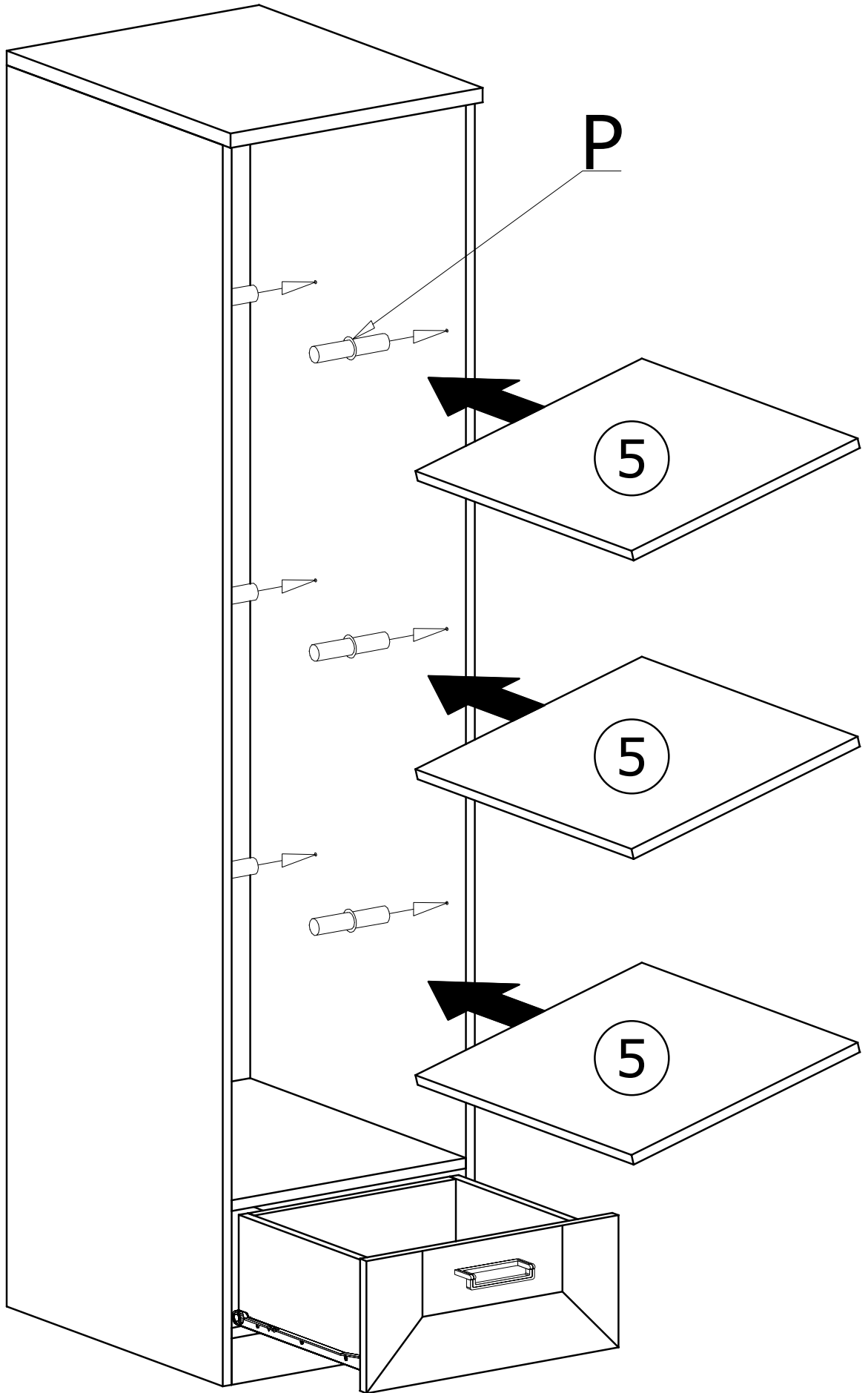

IV

