

TADEUSZ 4



Narzędzia potrzebne do montażu



UWAGA !!!

MONTOWANIE USZKODZONYCH
ELEMENTÓW POWODUJE UTRATĘ
GWARANCJI

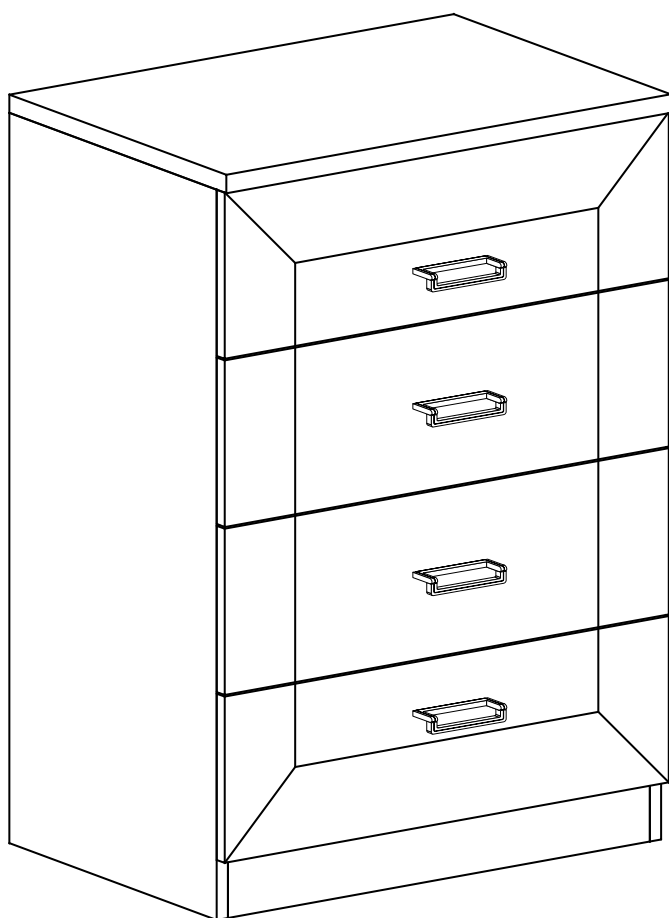

Nr	D[mm]	S[mm]	G[mm]	Ilość
1	635	440	32	1
2	585	405	16	1
3	865	405	16	1
4	865	405	16	1
5	585	80	16	1
6	612	808	2,5	1
7	527	150	16	4
8	405	150	16	4
9	405	150	16	4
10	603	190	16	4
11	555	405	2,5	4

W przypadku reklamacji proszę podać numer pakowacza znajdujący się na kartonie.

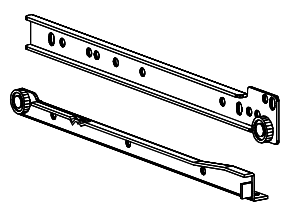

T - 4 Kpl.

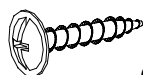

Q - 4 St.
3,5x16 mm



P - 16 St.

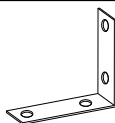

Y - 2 St.



U - 4 St.



Q - 4 St.



L - 12 St.

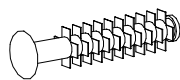

F - 16 St.

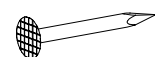

E - 80 St.

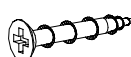

M - 16 St.
3x30 mm

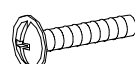

N - 8 St.
4x25 mm



S - 1 St.

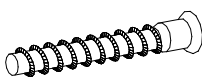

R - 4 St.



B - 28 St.

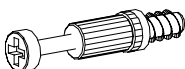

K - 12 St.

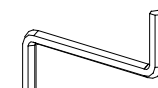

Z - 1 St.



J - 16 St.
4x13 mm

I

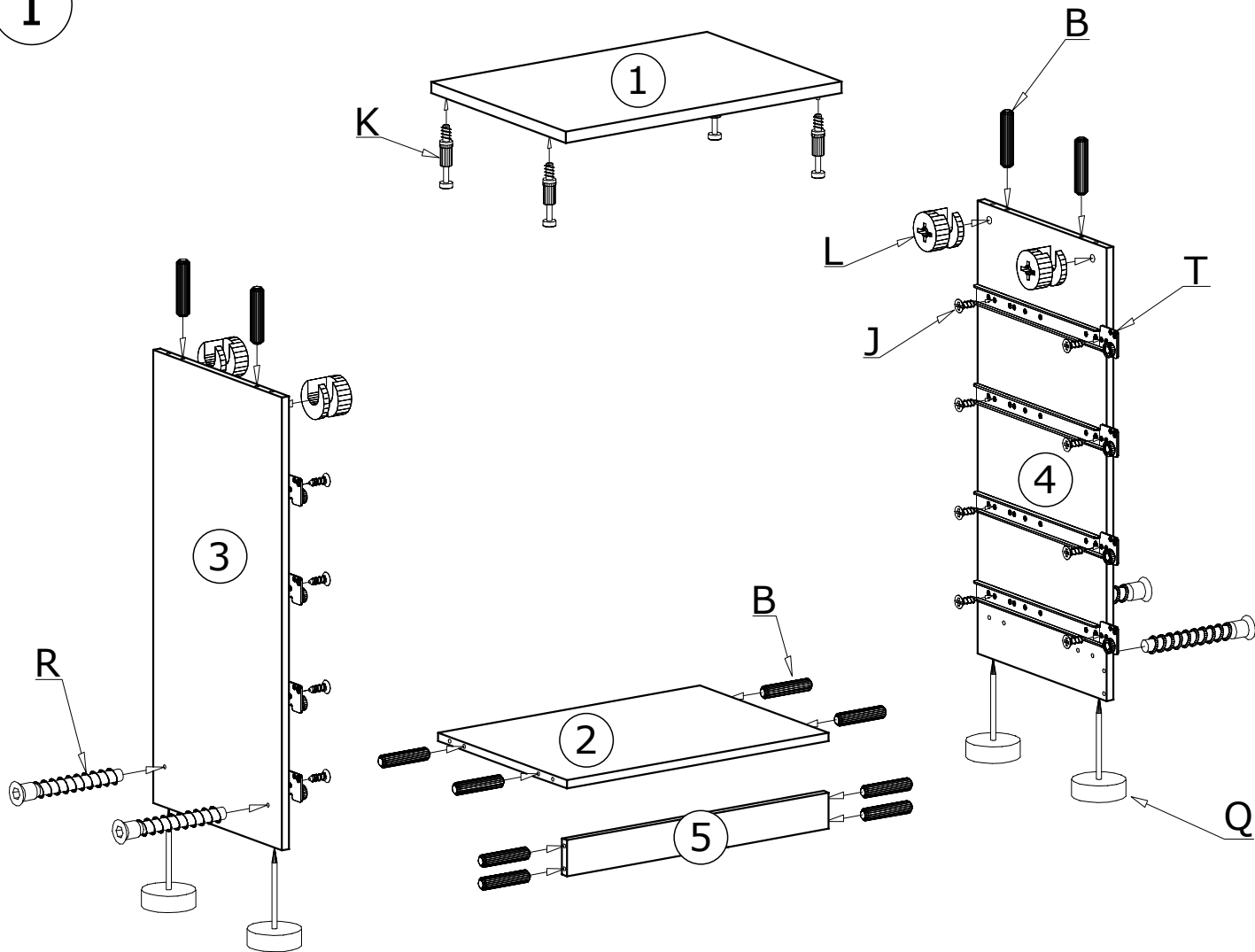

II

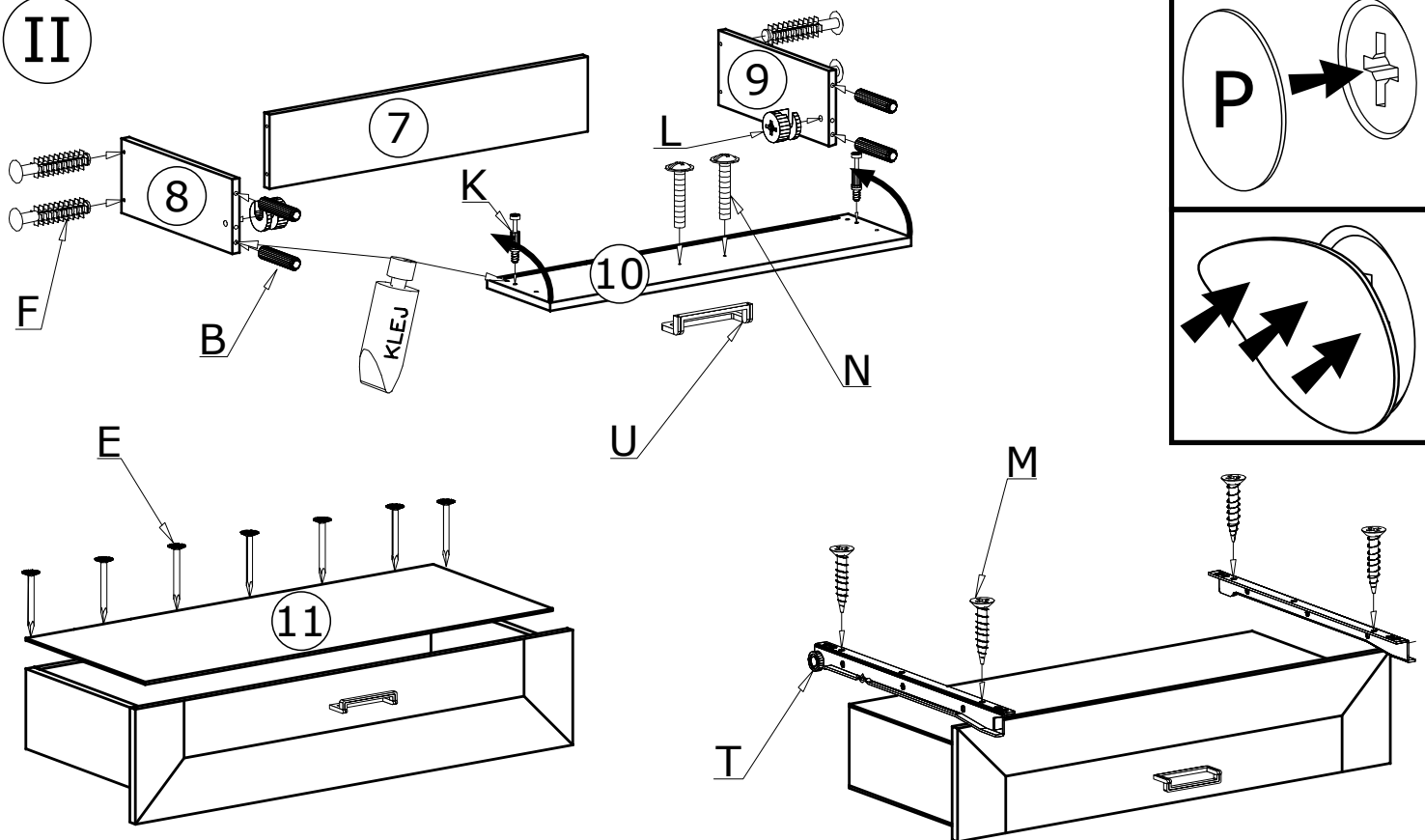

III

80X 

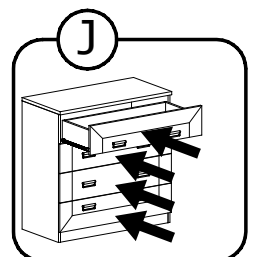
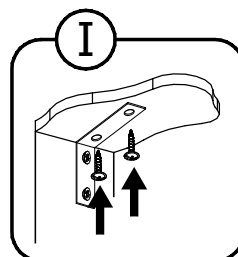
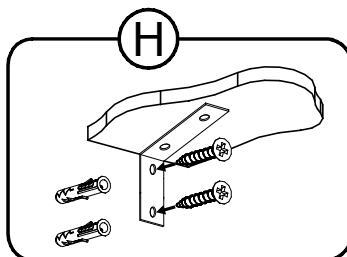
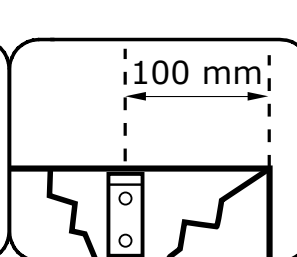
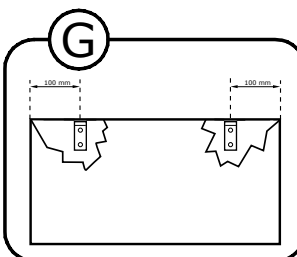
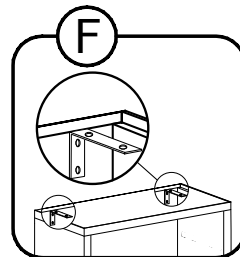
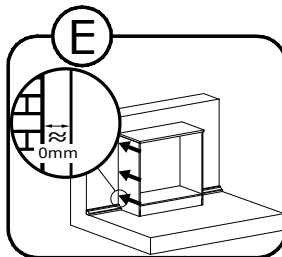
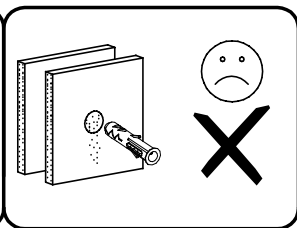
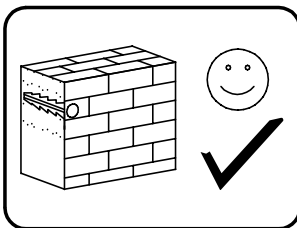
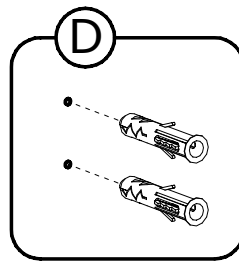
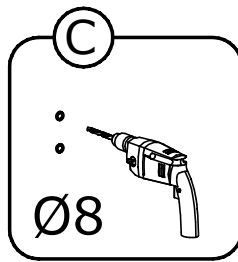
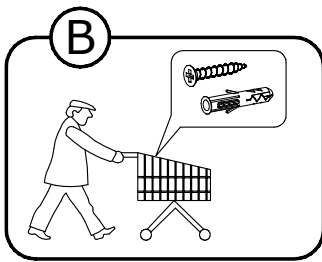
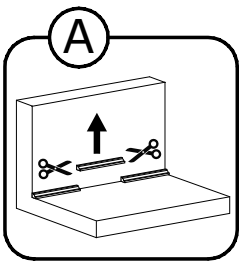
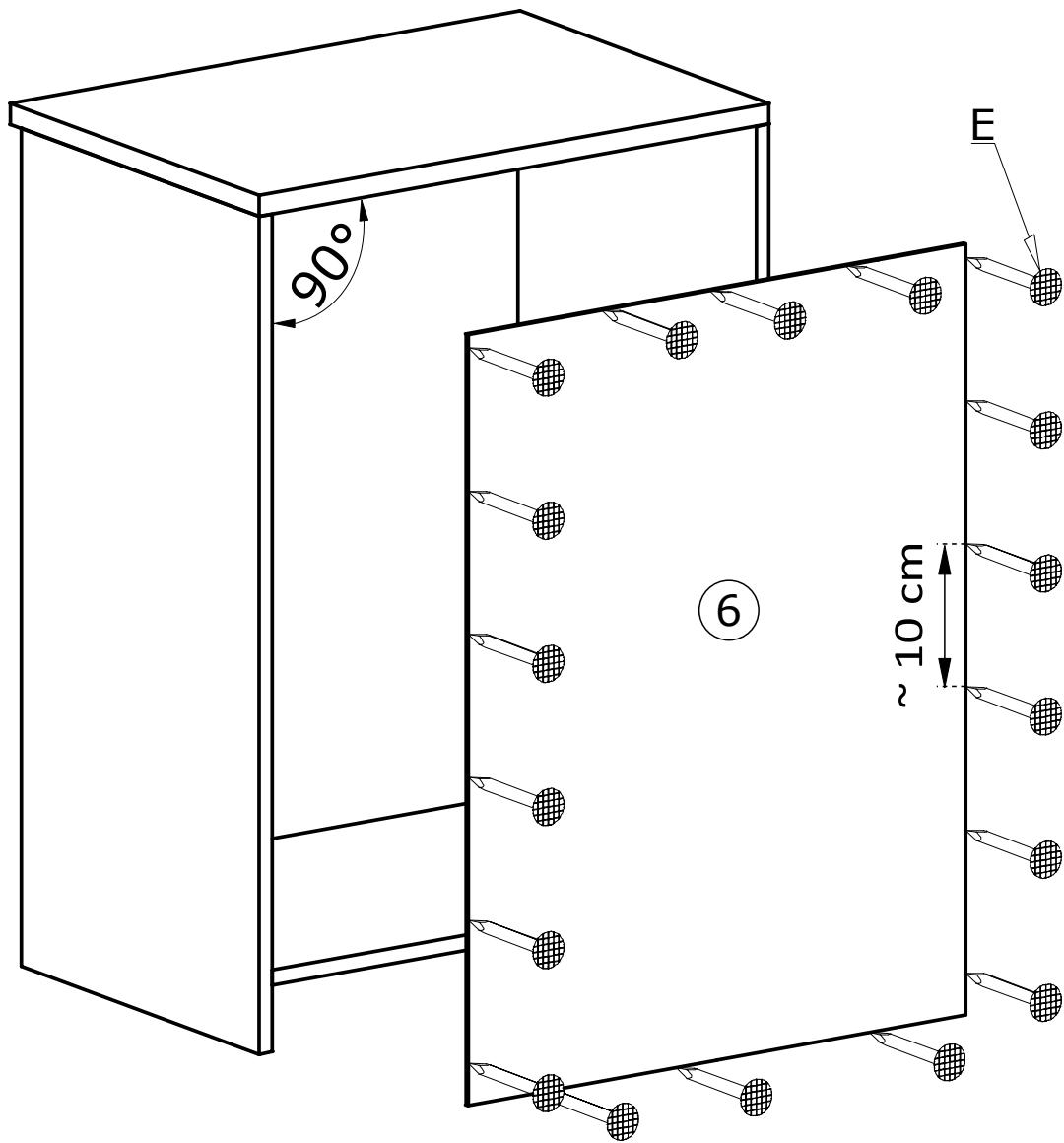

IV

