

# TADEUSZ 3



Narzędzia potrzebne do montażu



## **UWAGA !!!**

MONTOWANIE USZKODZONYCH  
ELEMENTÓW POWODUJE UTRATĘ  
GWARANCJI

Nr	D[mm]	S[mm]	G[mm]	Ilość
1	1000	440	32	1
2	950	405	16	1
3	950	405	16	1
4	952	80	16	1
5	865	405	16	1
6	865	405	16	1
7	775	488	16	1
8	775	488	16	1
9	978	806	2,5	1

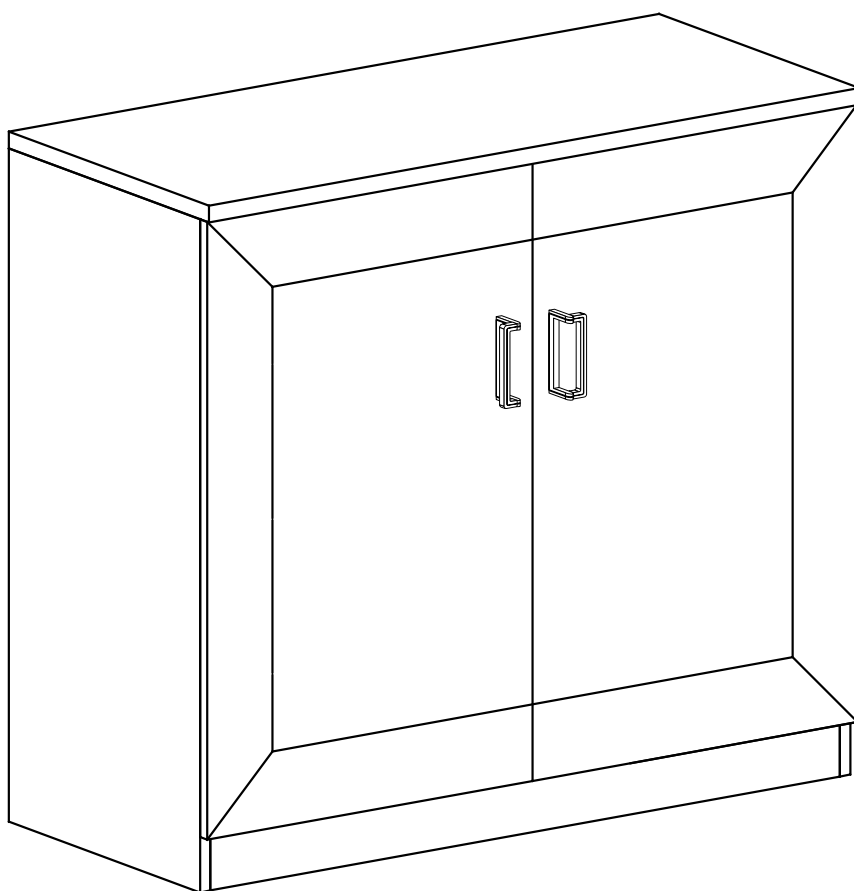

W przypadku reklamacji proszę podać numer pakowacza znajdujący się na kartonie.

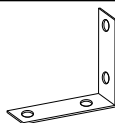

**Y - 2 St.**

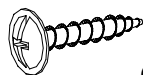

**Q - 4 St.**  
3,5x16 mm



**U - 2 St.**



**G - 8 St.**  
3,5x16 mm



**L - 4 St.**

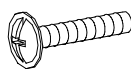

**N - 4 St.**  
4x25 mm



**E - 30 St.**

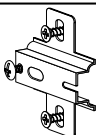

**C - 4 St.**

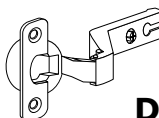

**D - 4 St.**



**S - 1 St.**

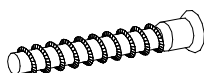

**R - 9 St.**



**B - 12 St.**

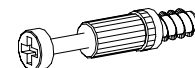

**K - 4 St.**

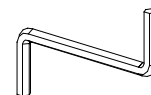

**Z - 1 St.**



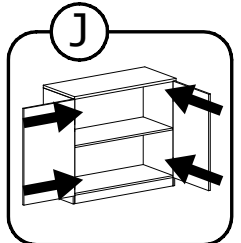
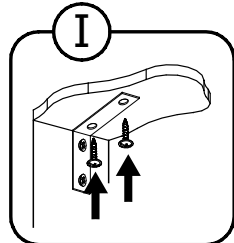
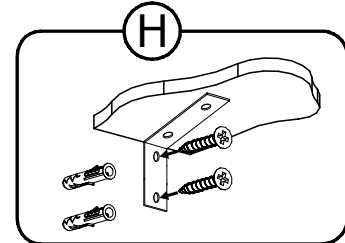
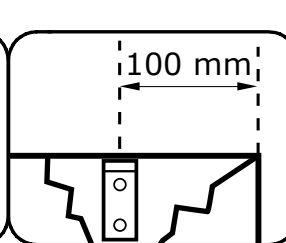
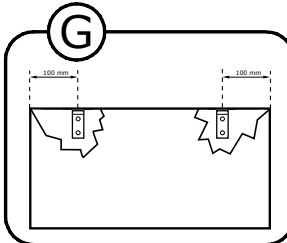
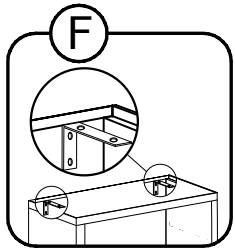
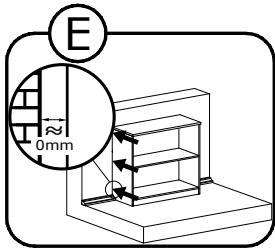
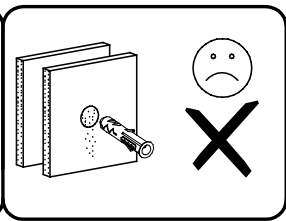
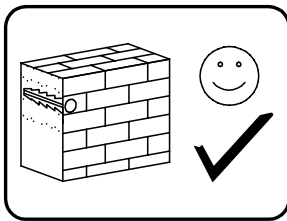
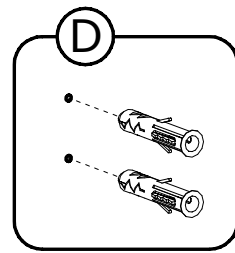
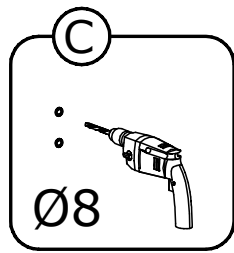
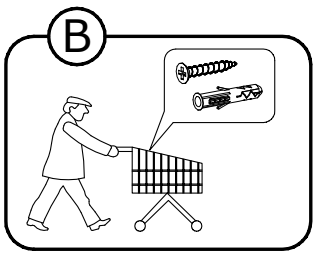
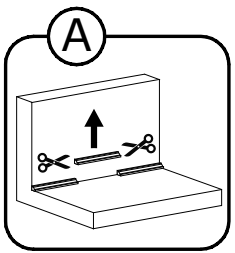
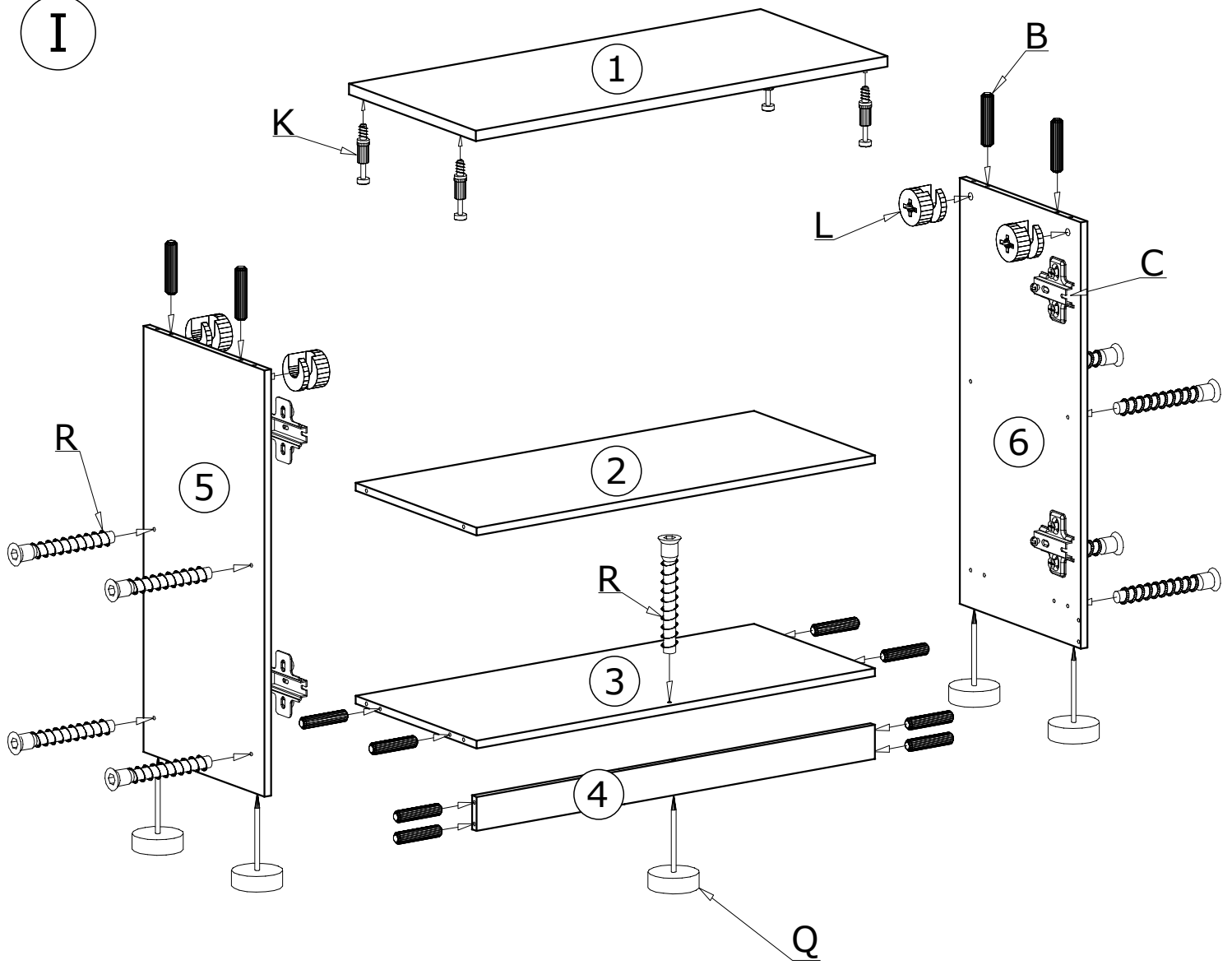

**Q - 5 St.**

I

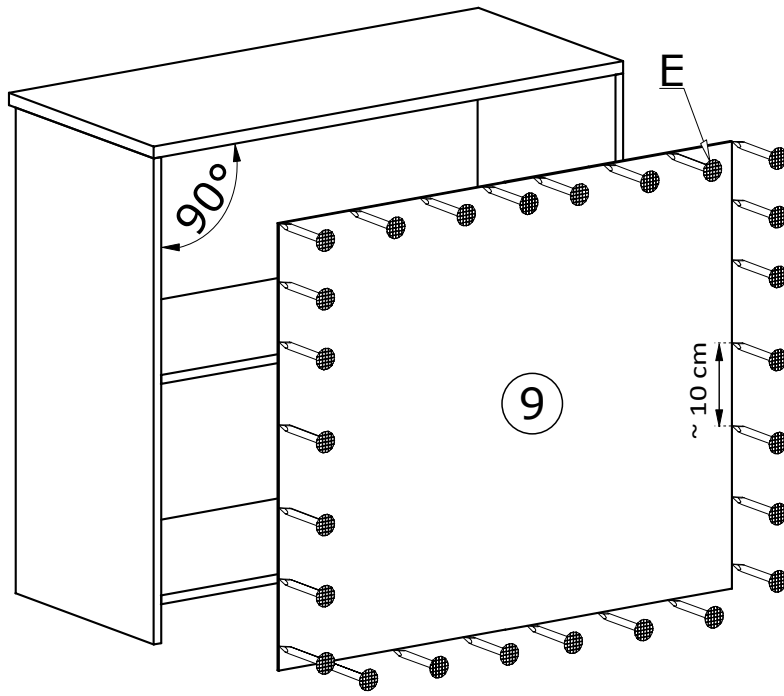

II



30X 

III

