

# TADEUSZ 2

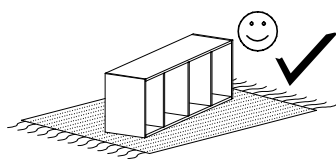

Narzędzia potrzebne do montażu



## UWAGA !!!

MONTOWANIE USZKODZONYCH  
ELEMENTÓW POWODUJE UTRATĘ  
GWARANCJI

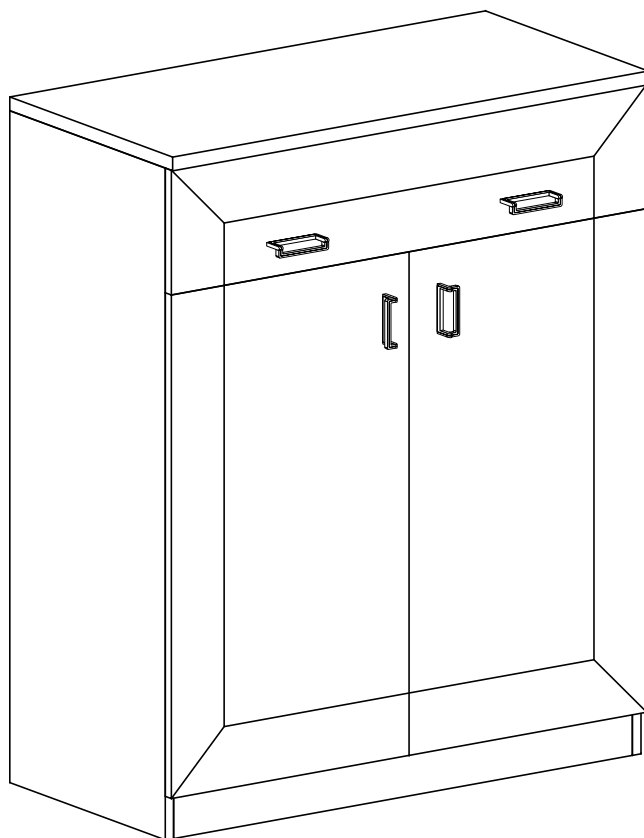

Nr	D[mm]	S[mm]	G[mm]	Ilość
1	900	440	32	1
2	852	405	16	1
3	852	405	16	1
4	1060	405	16	1
5	1060	405	16	1
6	852	80	16	1
7	1010	874	2,5	1
8	793	150	16	1
9	400	150	16	1
10	400	150	16	1
11	882	190	16	1
12	823	405	2,5	1
13	775	440	16	1
14	775	440	16	1

W przypadku reklamacji proszę podać numer pakowacza znajdujący się na kartonie.

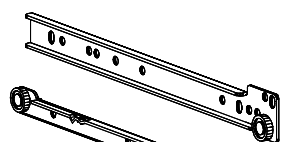

**T - 1 Kpl.**

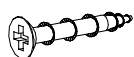

**M - 4 St.**  
4x25 mm



**Q - 5 St.**

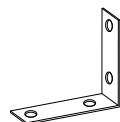

**Y - 2 St.**



**Q - 4 St.**  
3,5x16 mm

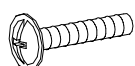

**N - 8 St.**  
4x25 mm



**U - 4 St.**



**G - 8 St.**  
3,5x16 mm



**L - 4 St.**

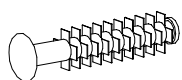

**F - 4 St.**



**E - 50 St.**

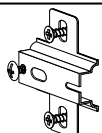

**C - 4 St.**

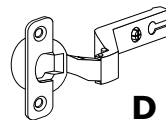

**D - 4 St.**



**S - 1 St.**

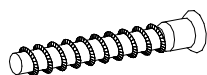

**R - 9 St.**



**B - 16 St.**

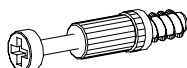

**K - 4 St.**

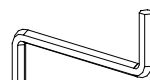

**Z - 1 St.**



**J - 4 St.**  
5x13 mm



III

50X 

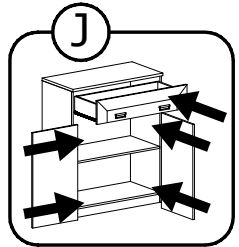
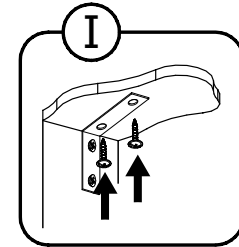
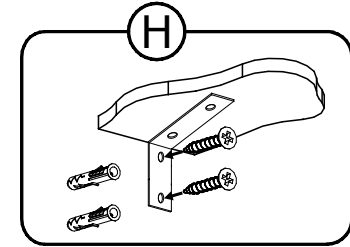
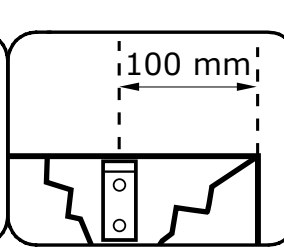
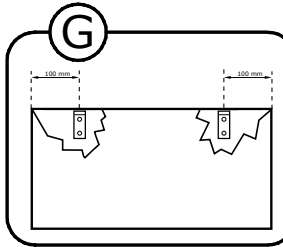
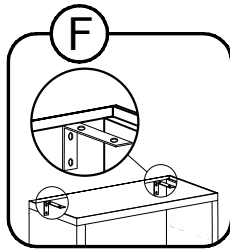
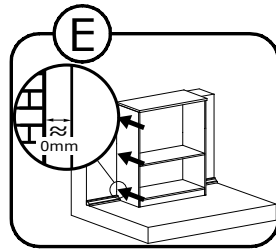
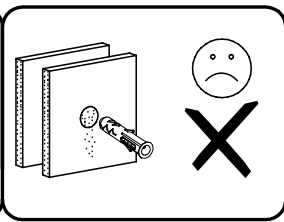
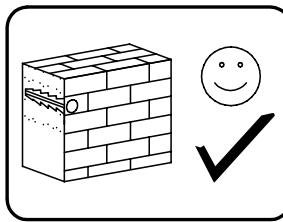
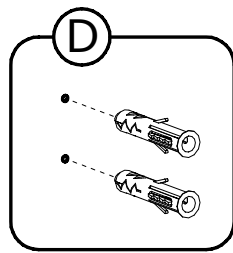
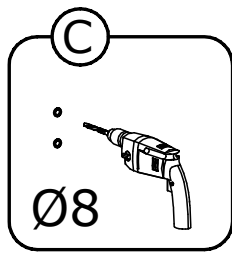
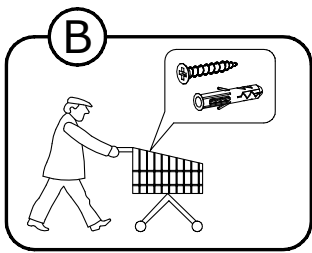
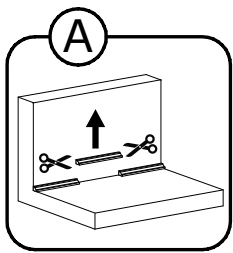
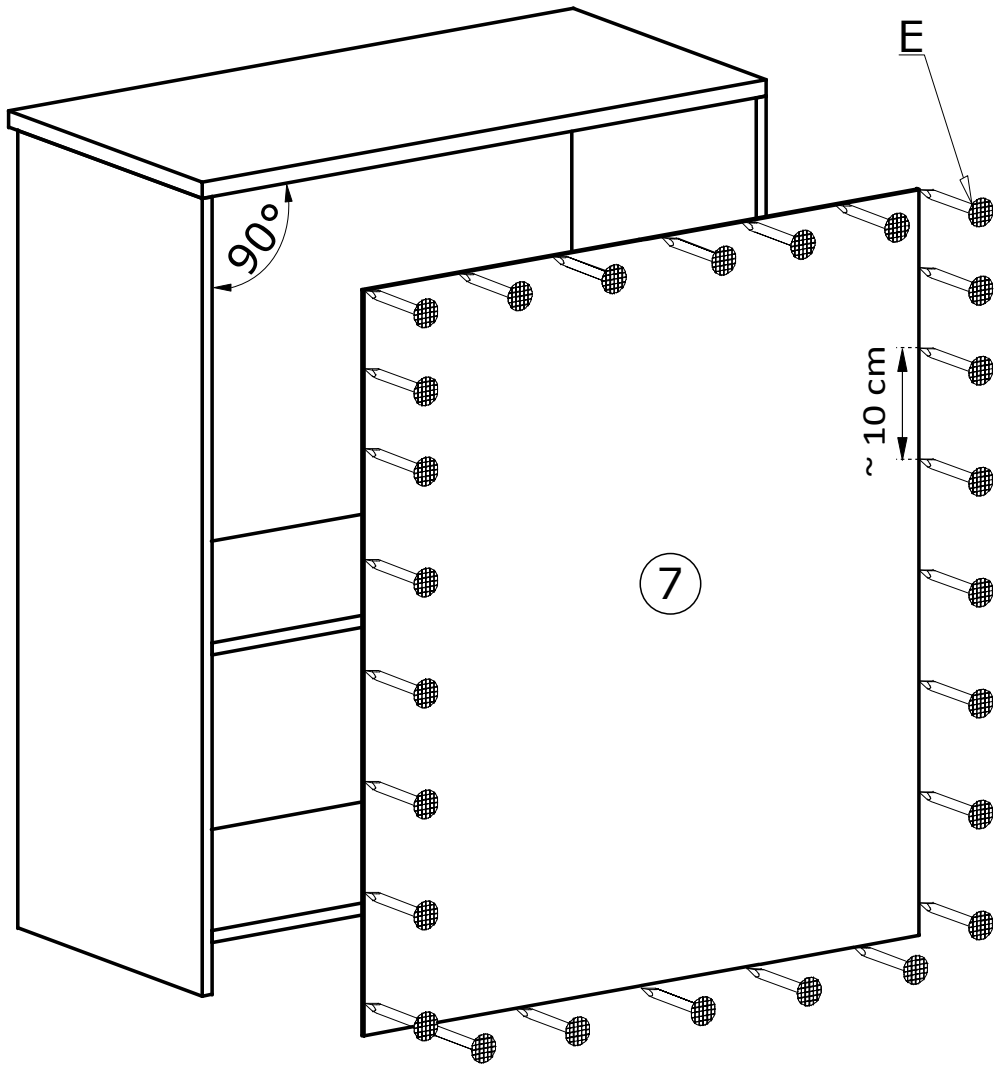

IV

