

# TADEUSZ 1

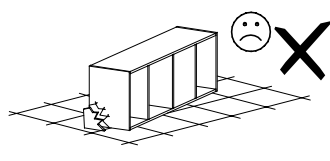

Narzędzia potrzebne do montażu

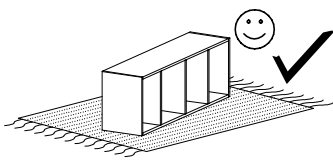
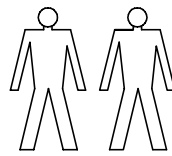
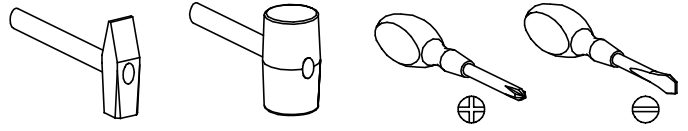

## UWAGA !!!

MONTOWANIE USZKODZONYCH  
ELEMENTÓW POWODUJE UTRATĘ  
GWARANCJI

Nr	D[mm]	S[mm]	G[mm]	Ilość
1	900	440	32	1
2	852	406	16	1
3	865	405	16	1
4	405	405	16	1
5	852	80	16	1
6	877	806	2,5	1
7	793	150	16	4
8	400	150	16	4
9	400	150	16	4
10	880	190	16	4
11	823	405	2,5	4

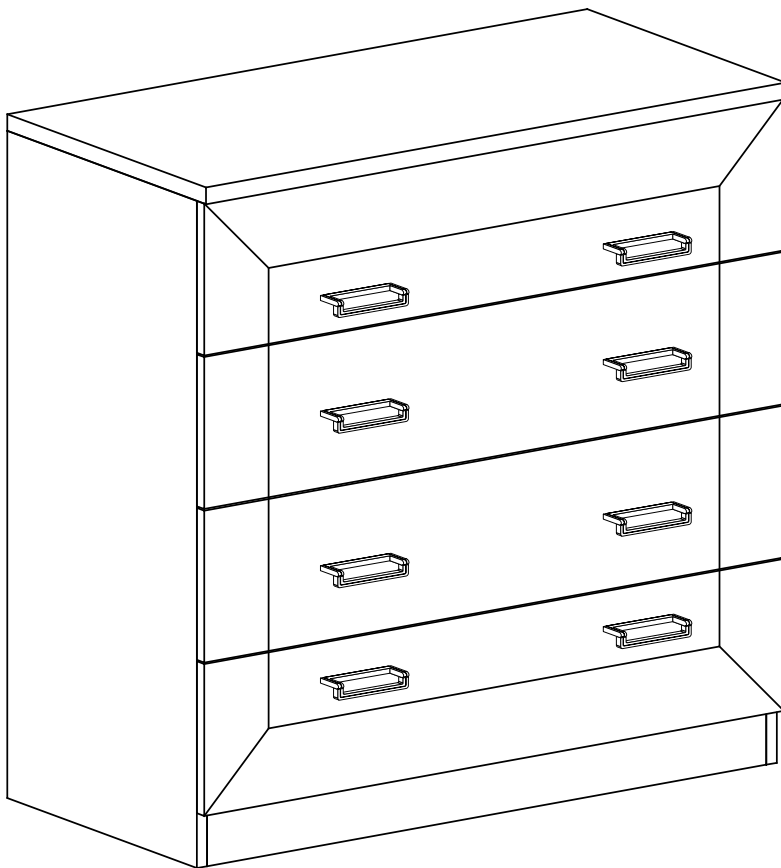

W przypadku reklamacji proszę podać numer pakowacza znajdujący się na kartonie.

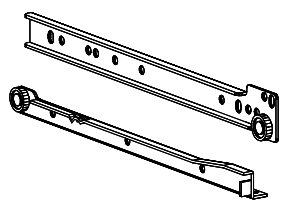

**T - 4 Kpl.**

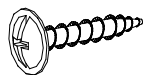

**I - 4 St.**  
3,5x16 mm

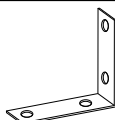

**Y - 2 St.**

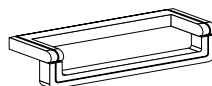

**U - 8 St.**

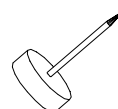

**Q - 5 St.**



**L - 4 St.**

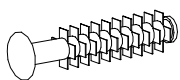

**F - 16 St.**



**E - 80 St.**

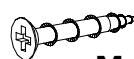

**M - 16 St.**  
4x25 mm

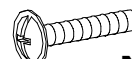

**N - 16 St.**  
4x25 mm



**S - 1 St.**

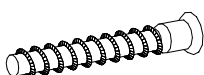

**R - 5 St.**



**B - 28 St.**

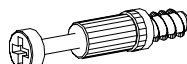

**K - 4 St.**

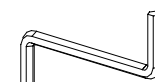

**Z - 1 St.**



**J - 16 St.**  
5x13 mm

I

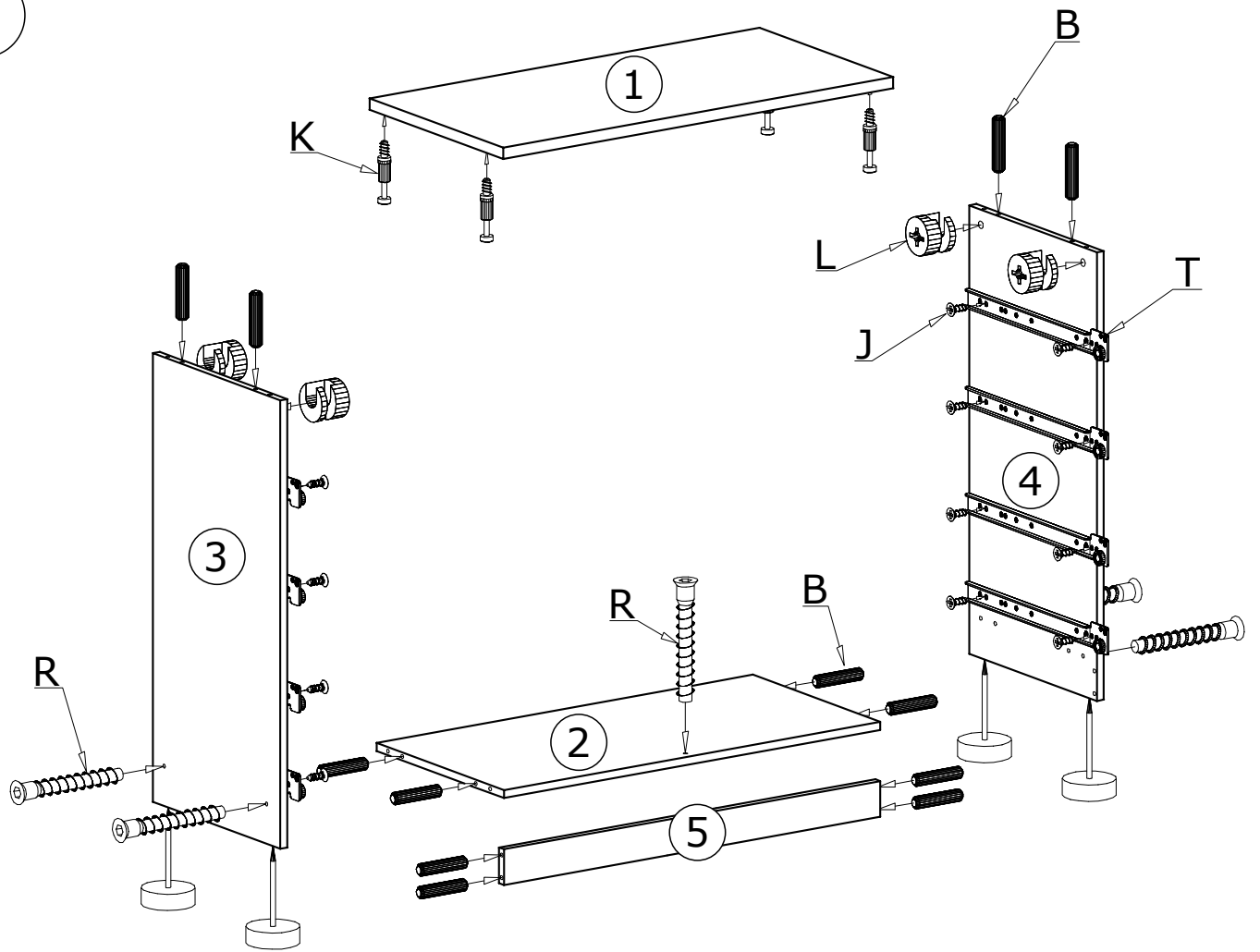

II

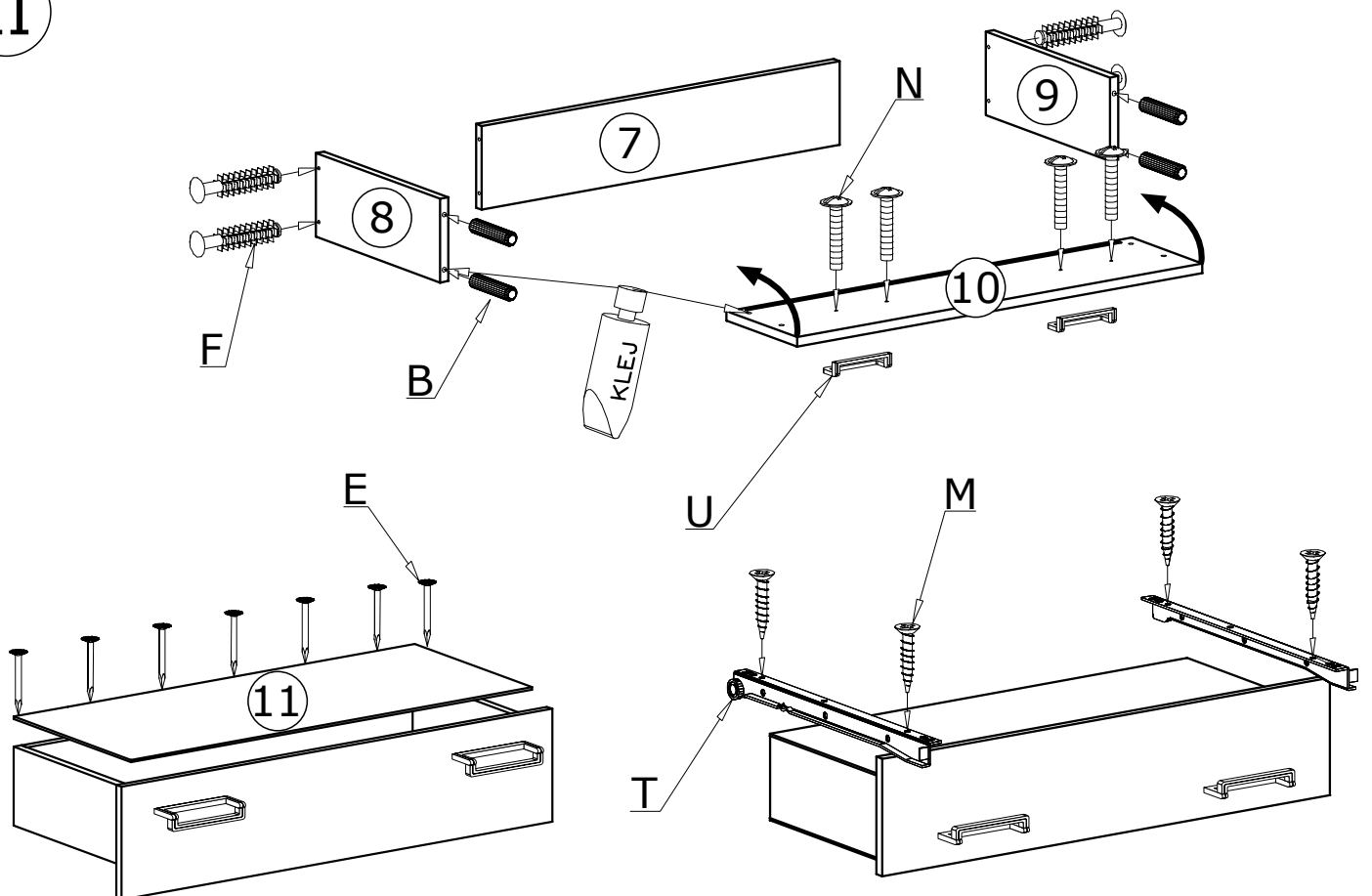

III

80X 

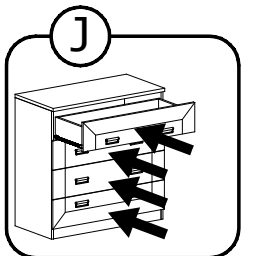
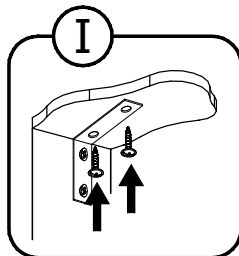
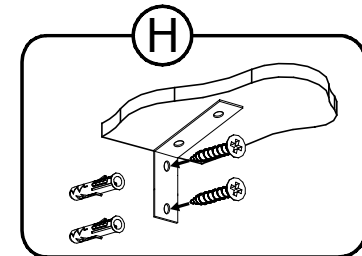
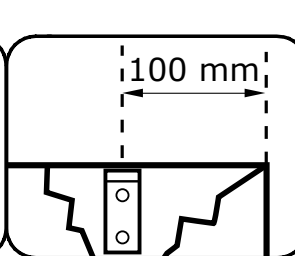
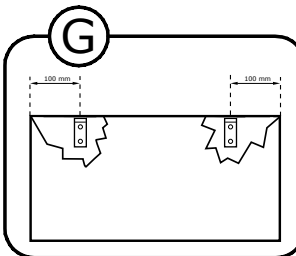
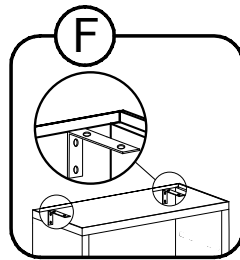
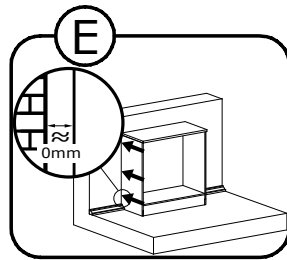
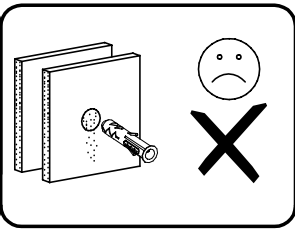
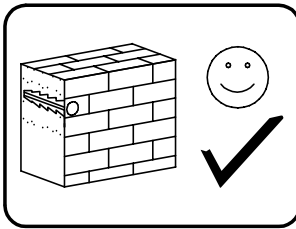
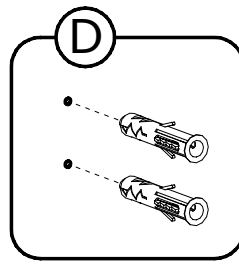
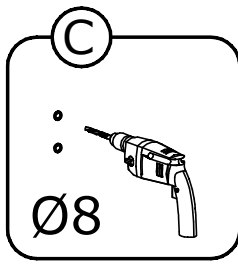
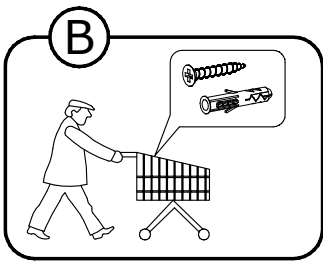
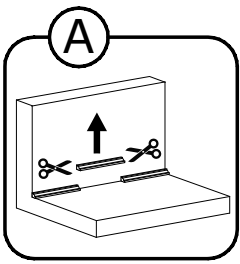
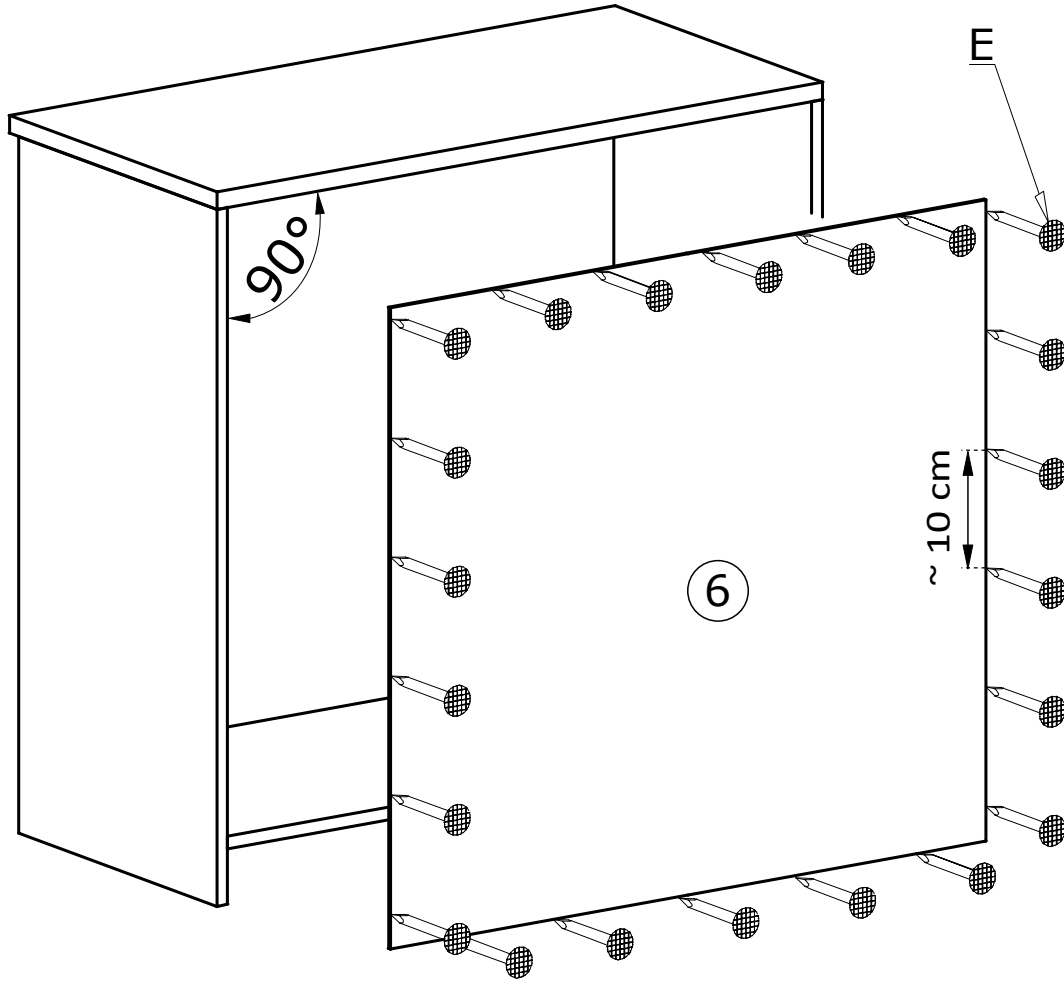

IV

