

DALLAS 20

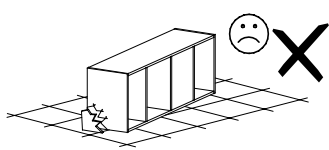

Narzędzia potrzebne do montażu

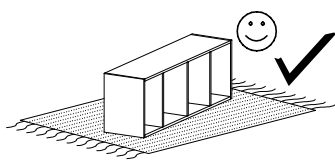
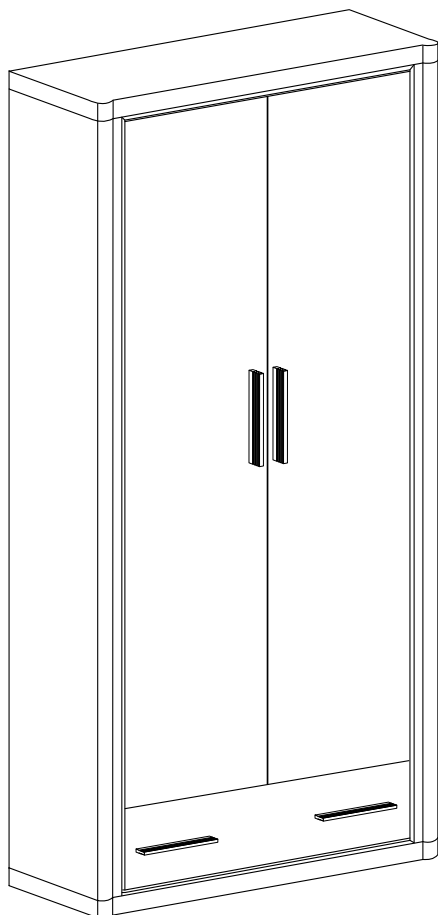

UWAGA !!!

MONTOWANIE USZKODZONYCH
ELEMENTÓW POWODUJE UTRATĘ
GWARANCJI

Nr	D[mm]	S[mm]	G[mm]	Ilość
1	970	590	48	1
2	970	590	48	1
3	930	25	16	2
4	1810	562	16	1
5	1810	562	16	1
6	1810	100	32	1
7	1810	100	32	1
8	545	200	16	1
9	545	200	16	1
10	935	545	16	1
11	1835	960	2,5	1
12	770	190	16	1
13	500	150	16	1
14	500	150	16	1
15	695	150	16	1
16	723	505	2,5	1
17	1620	380	16	2
18	935	80	16	1

W przypadku reklamacji proszę podać numer pakowacza znajdujący się na kartonie.

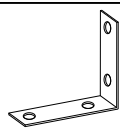

Y - 2 St.

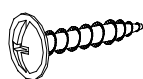

I - 4 St.
3,5x16 mm



X1 - 6 St.

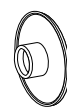

X2 - 8 St.



X3 - 4 St.

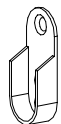

P - 2 St.

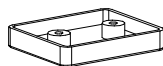

A - 4 St.

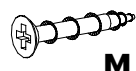

M - 12 St.
4x25 mm

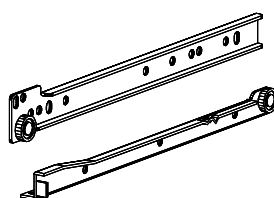

T - 1 Kpl.

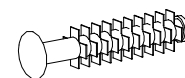

F - 4 St.



O - 1 St.



N - 8 St.
4x30 mm

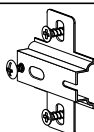

C - 6 St.

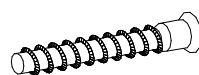

W - 6 St.



L - 22 St.

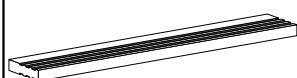

U - 4 St.

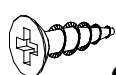

G - 20 St.
3,5x16 mm

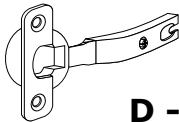

D - 6 St.

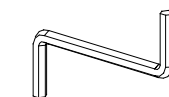

Z - 1 St.



S - 1 St.



E - 80 St.



B - 26 St.

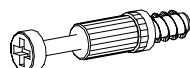

K - 22 St.



J - 4 St.
5x13 mm

I

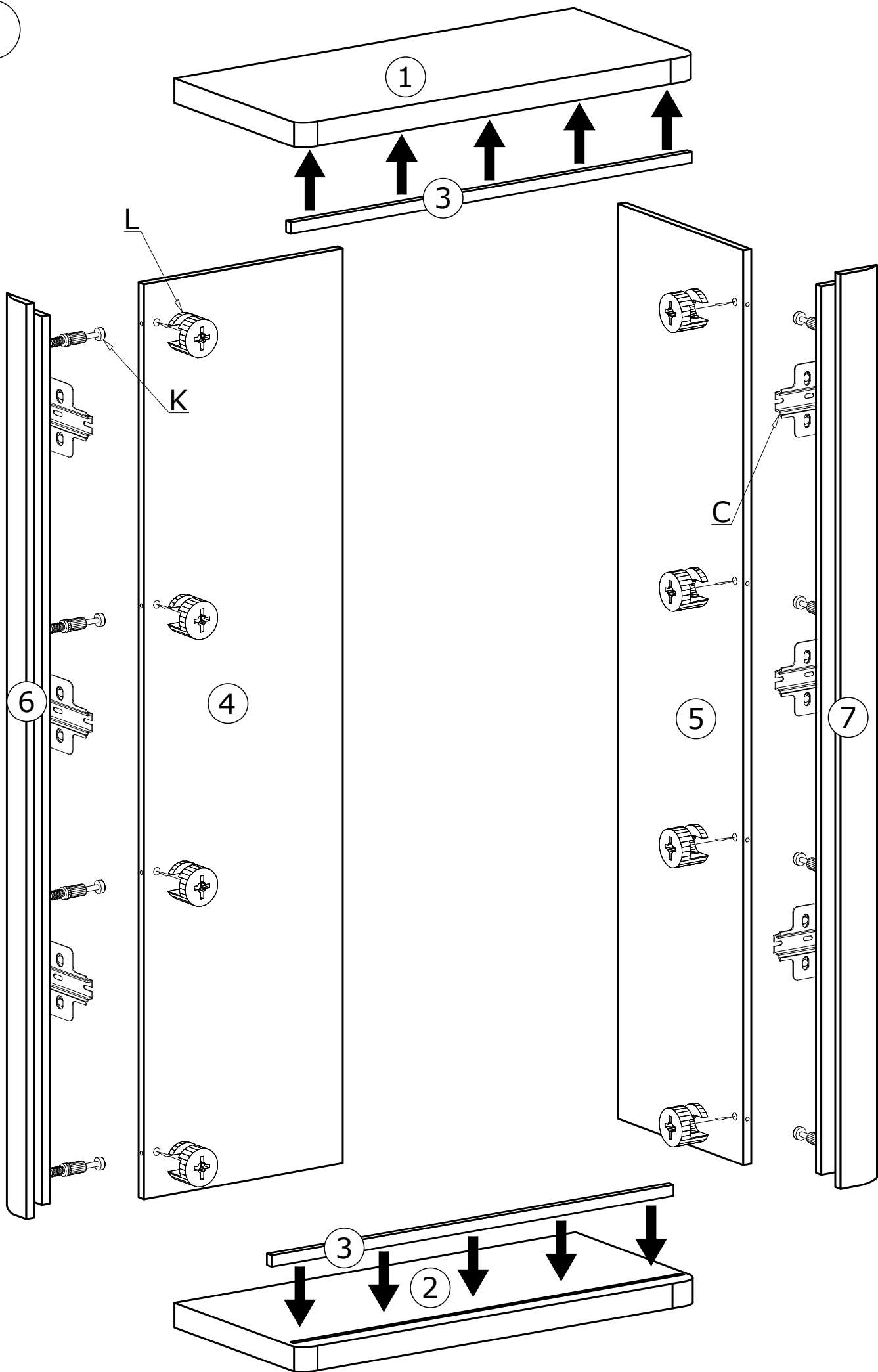

II

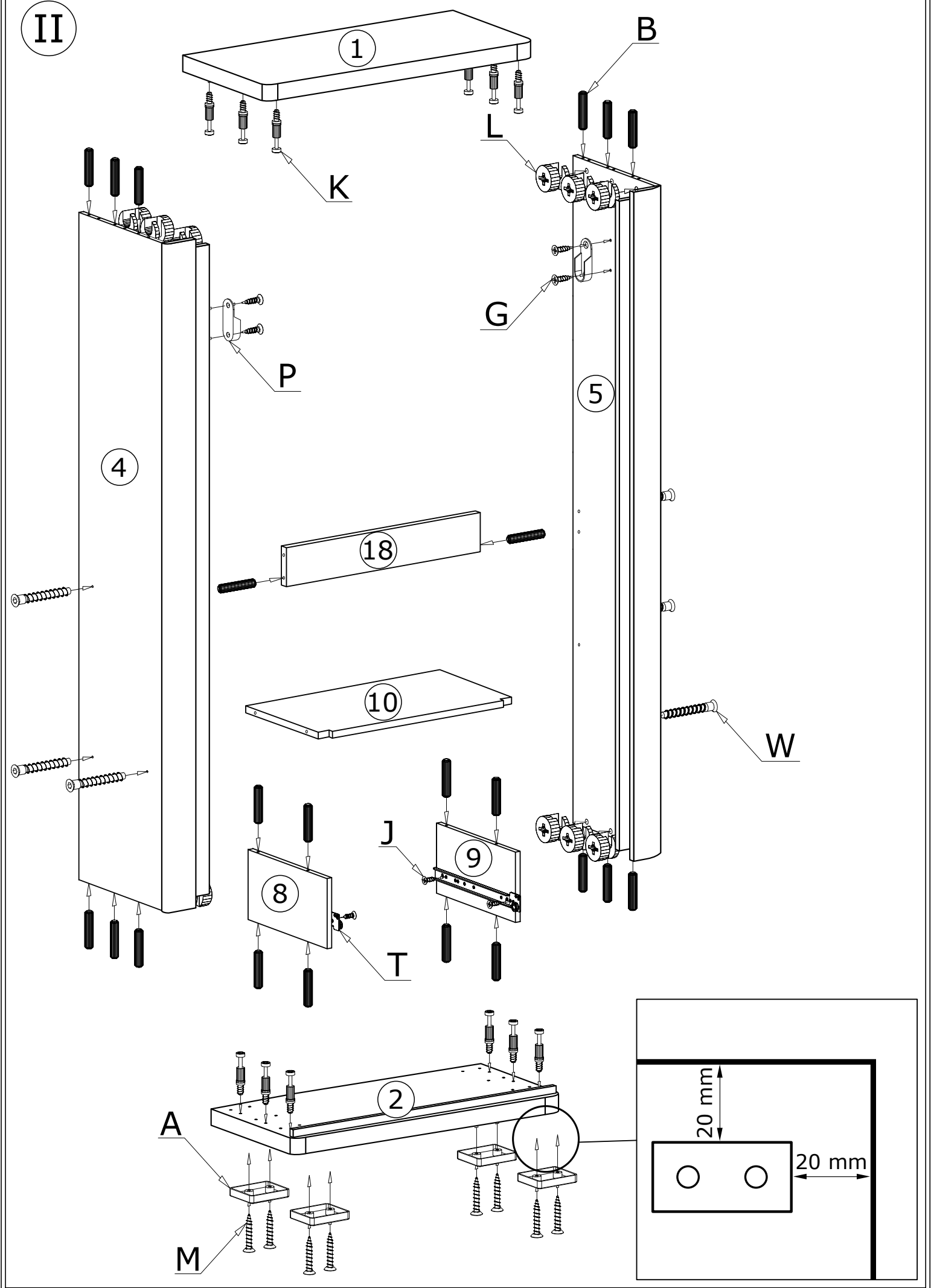

III

80X

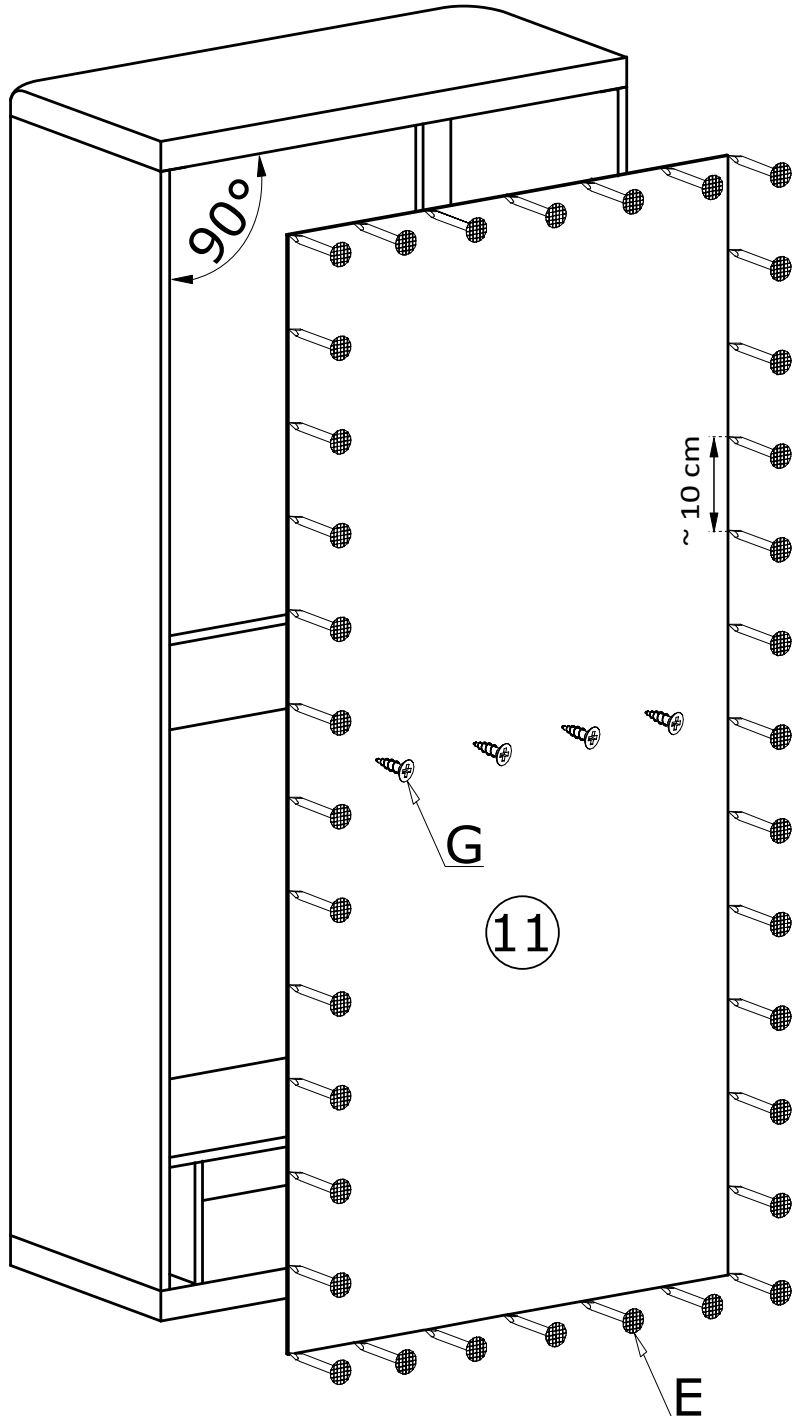

A

B

C

D

E

F

G

H

I

J

IV

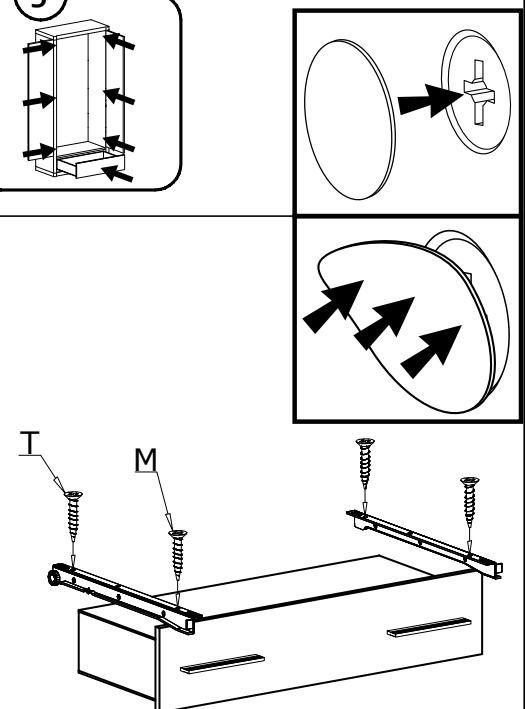
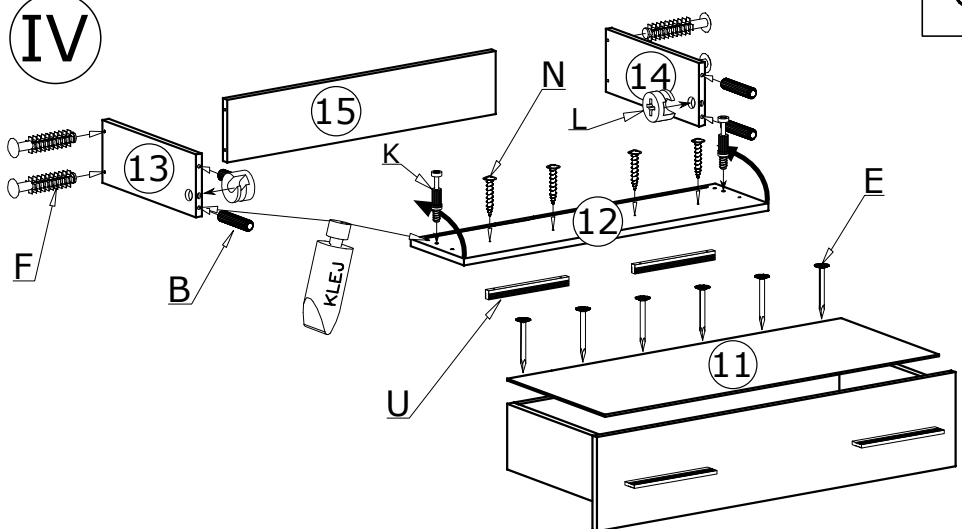

V

