

DALLAS 14



Narzędzia potrzebne do montażu



UWAGA !!!

MONTOWANIE USZKODZONYCH
ELEMENTÓW POWODUJE UTRATĘ
GWARANCJI

Nr	D[mm]	S[mm]	G[mm]	Ilość
1	560	93	32	4
2	560	55	32	4
3	808	545	12	1
4	808	100	12	2
5	899	633	48	1

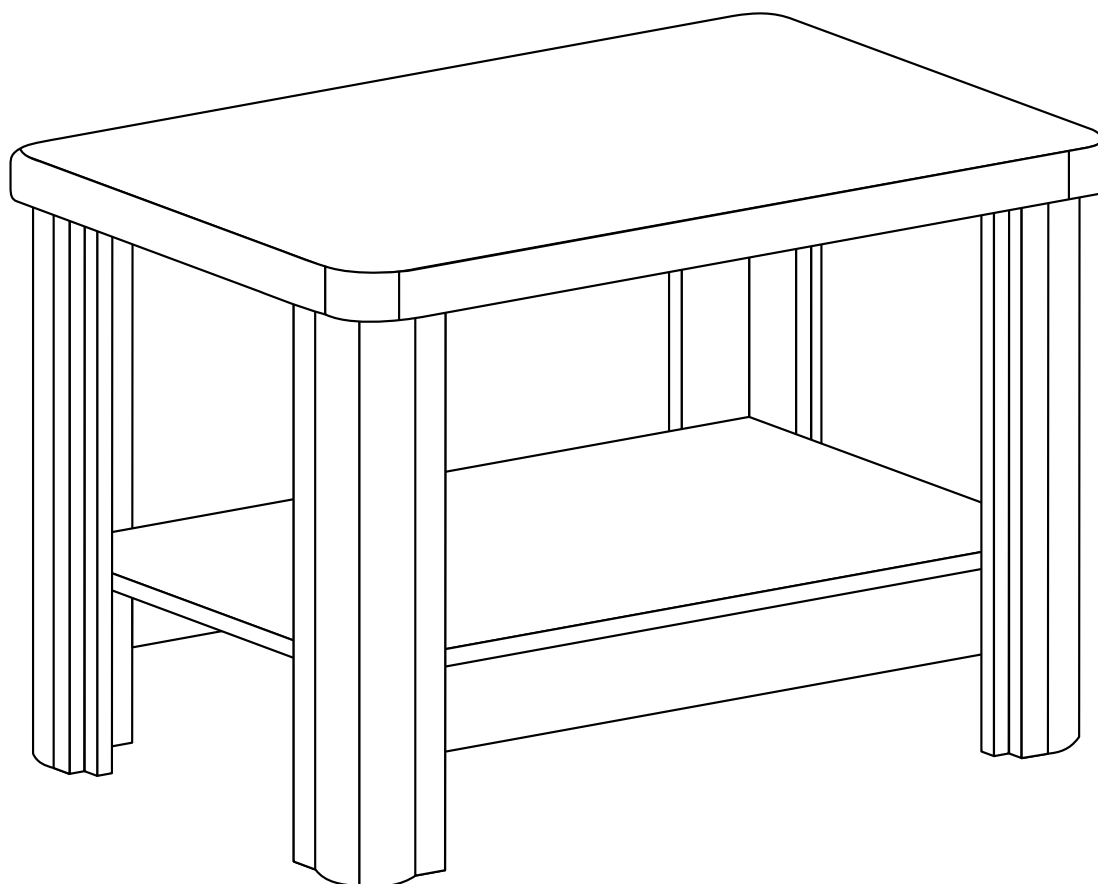

W przypadku reklamacji proszę podać numer pakowacza znajdujący się na kartonie.

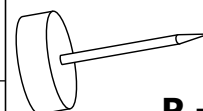

P - 8 St.

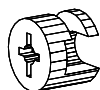

A - 22 St.



B - 10 St.

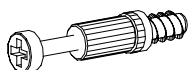

K - 22 St.

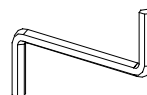

Z - 1 St.



S - 1 St.

I

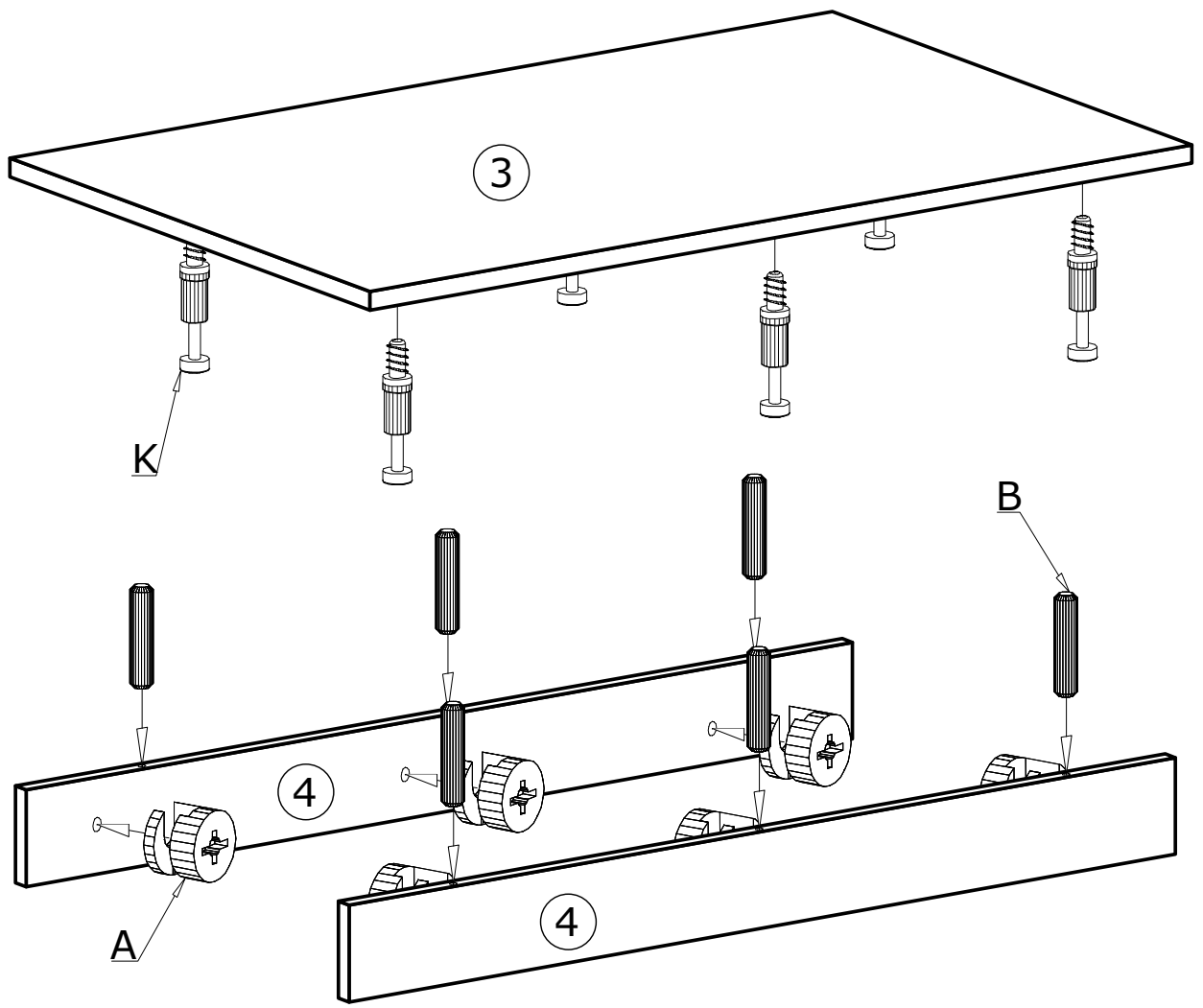

II

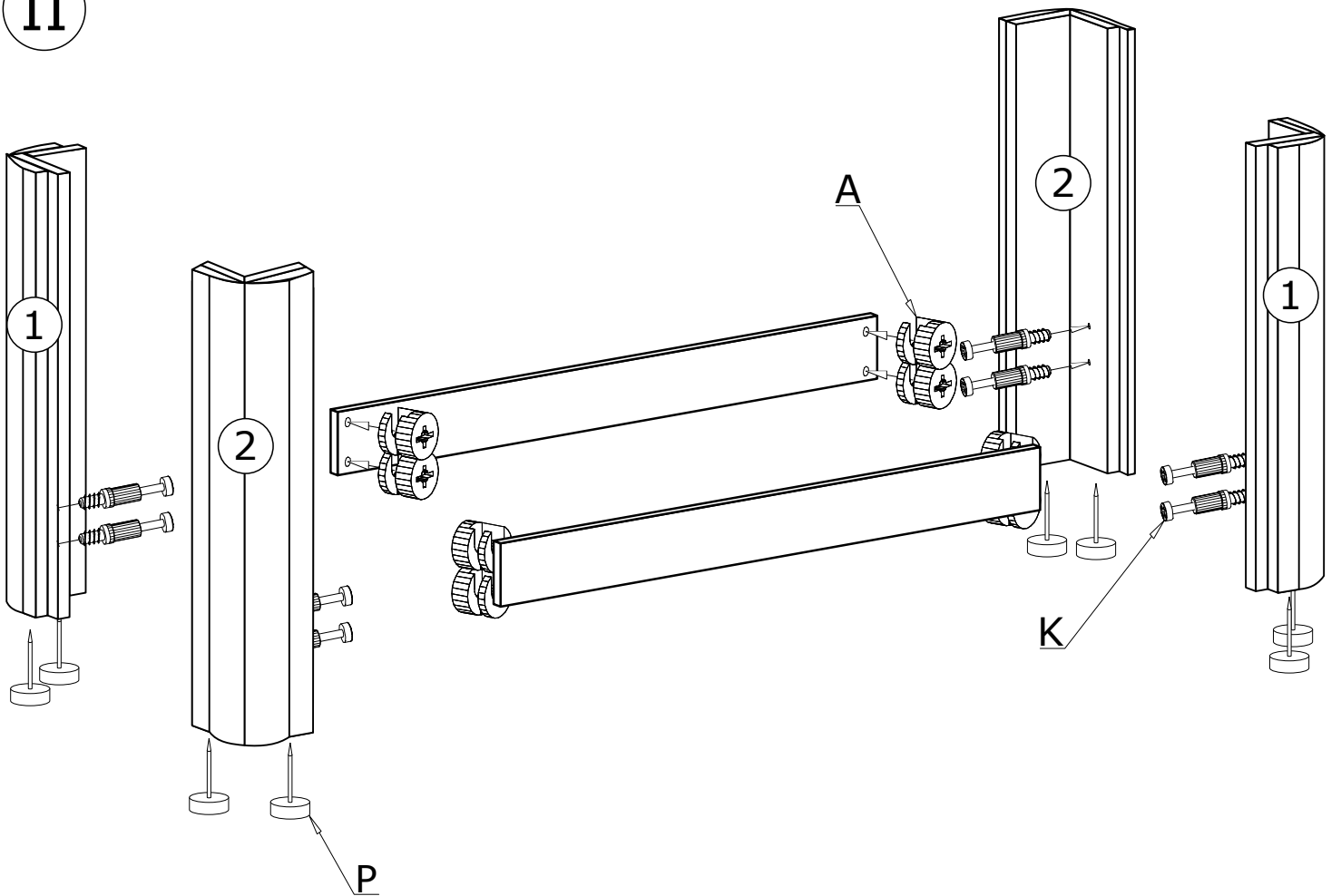

III

