

# DALLAS 6

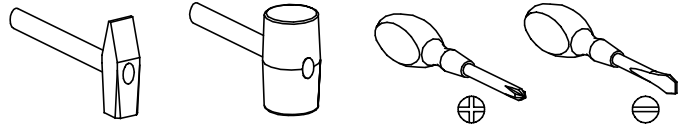

Narzędzia potrzebne do montażu



## UWAGA !!!

MONTOWANIE USZKODZONYCH  
ELEMENTÓW POWODUJE UTRATĘ  
GWARANCJI

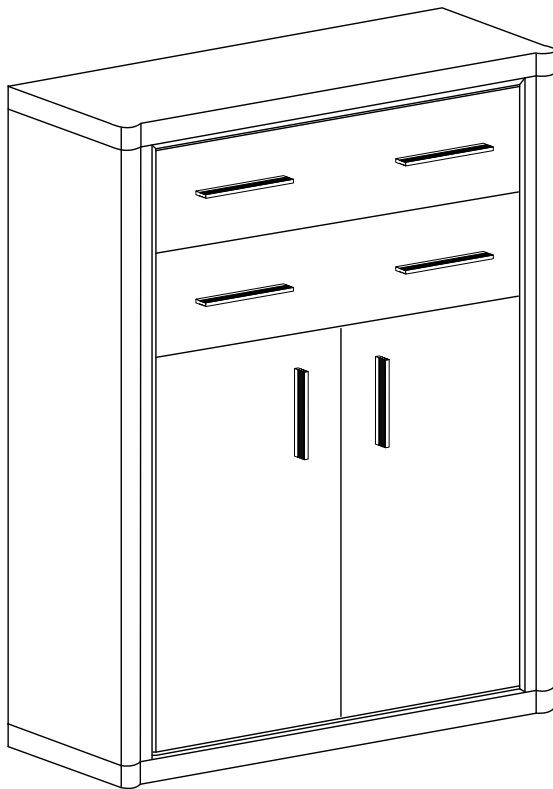

Nr	D[mm]	S[mm]	G[mm]	Ilość
1	970	450	48	1
2	970	450	48	1
3	930	25	16	2
4	1120	420	16	1
5	1120	420	16	1
6	1120	100	32	1
7	1120	100	32	1
8	395	405	16	1
9	395	405	16	1
10	935	405	16	1
11	935	380	16	1
12	1176	960	2,5	1
13	400	150	16	2
14	400	150	16	2
15	695	150	16	2
16	770	190	16	2
17	723	405	2,5	2
18	700	384	16	1
19	700	384	16	1

W przypadku reklamacji proszę podać numer pakowacza znajdujący się na kartonie.

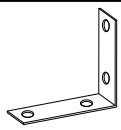

**Y - 2 St.**

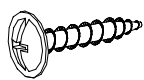

**I - 4 St.**  
3,5x16 mm

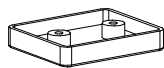

**A - 4 St.**

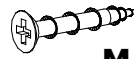

**M - 16 St.**  
4x25 mm

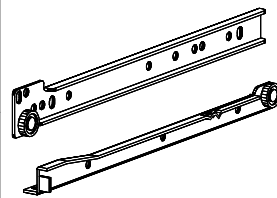

**F - 8 St.**

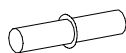

**P - 4 St.**

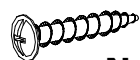

**N - 12 St.**  
4x30 mm

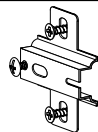

**C - 4 St.**

**T - 2 Kpl.**



**L - 14 St.**

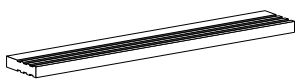

**U - 6 St.**



**G - 8 St.**  
3,5x16 mm

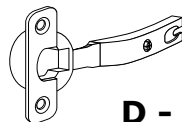

**D - 4 St.**



**W - 4 St.**



**S - 1 St.**



**E - 60 St.**



**B - 24 St.**

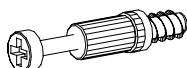

**K - 14 St.**

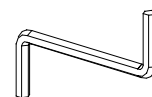

**Z - 1 St.**



**J - 8 St.**  
5x13 mm

I

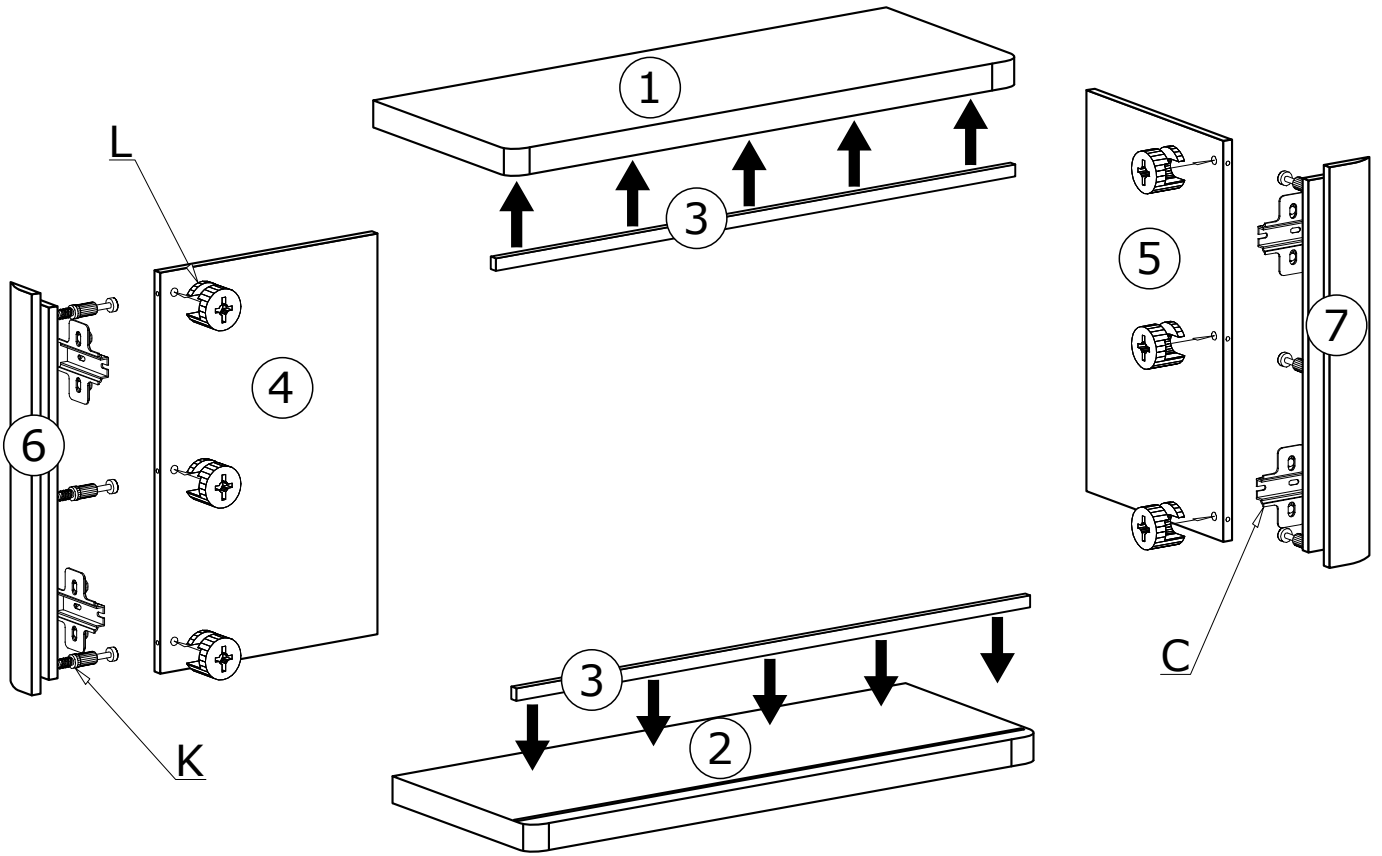

II

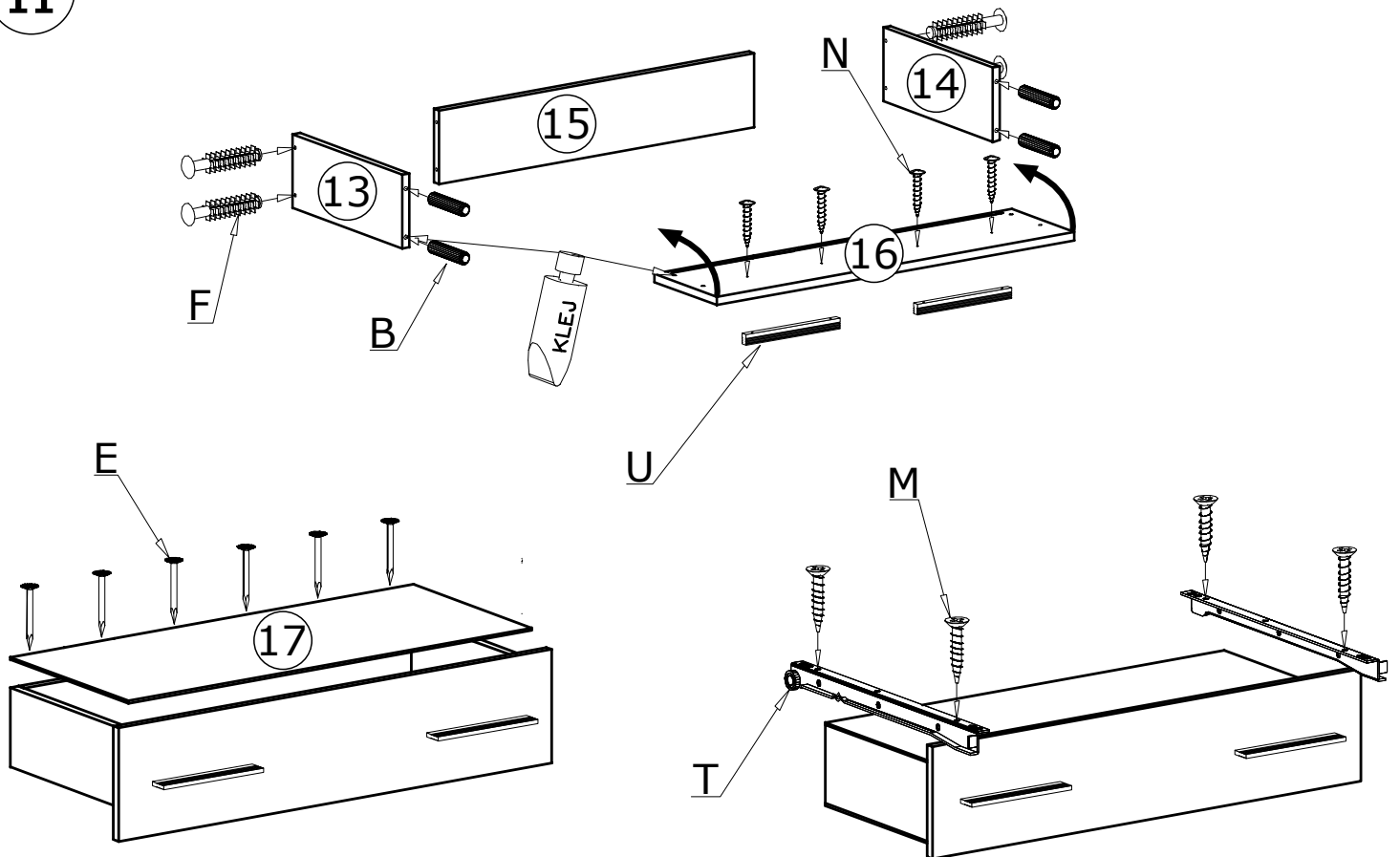

III

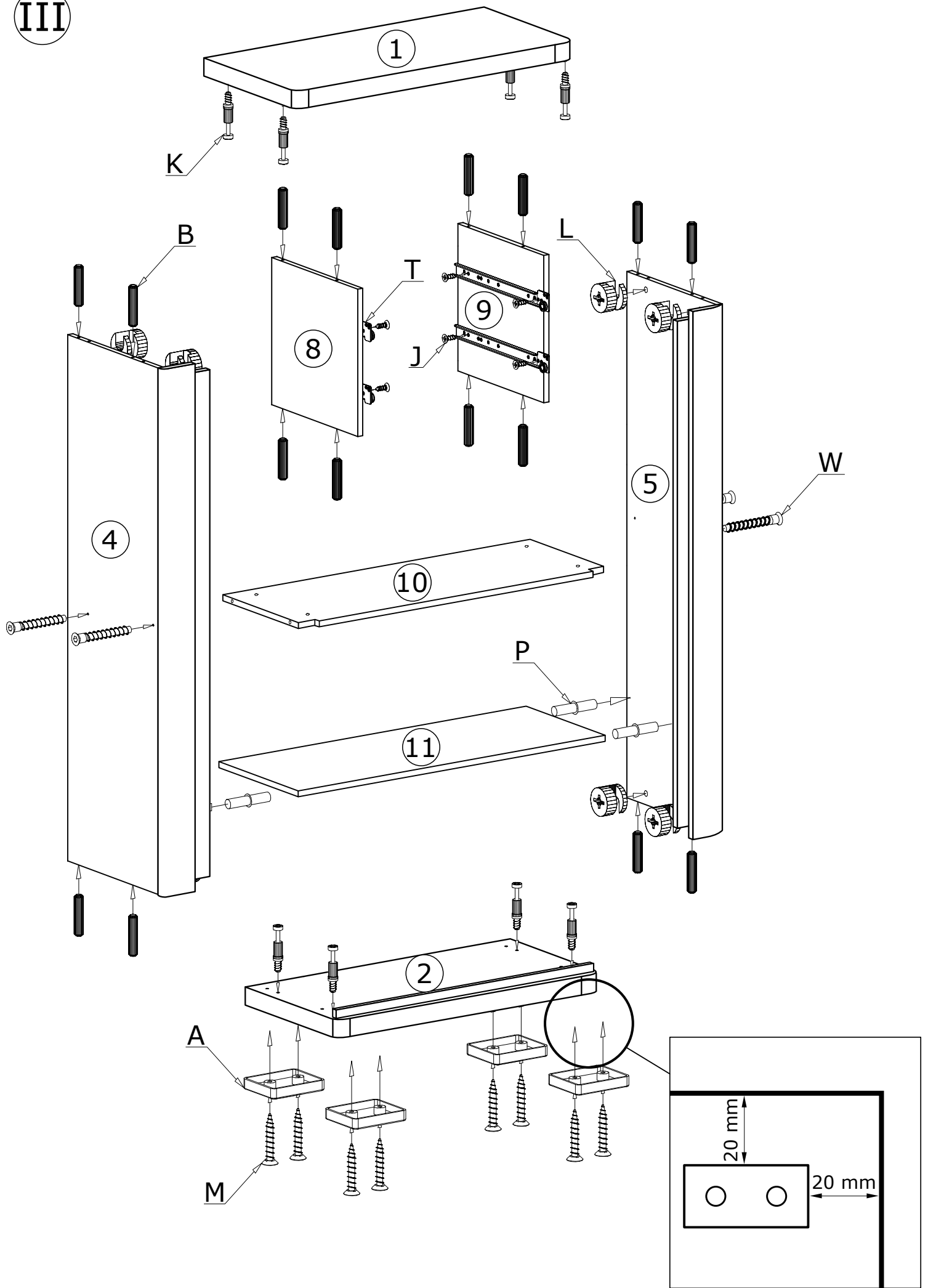

IV

60X 

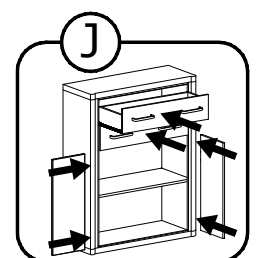
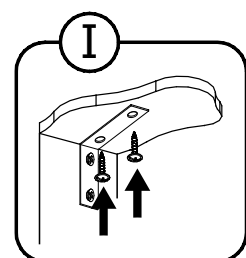
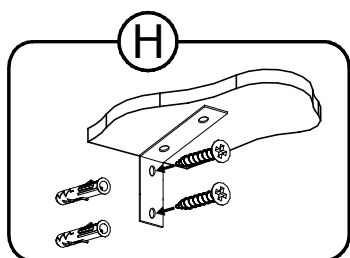
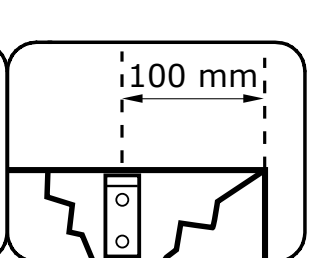
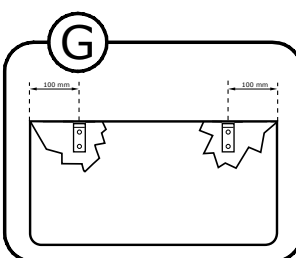
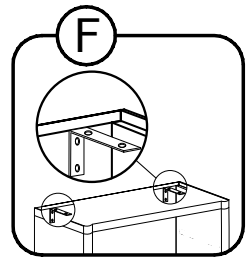
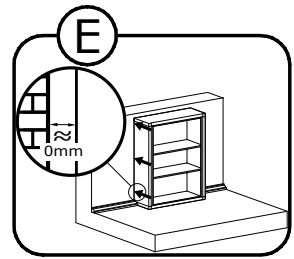
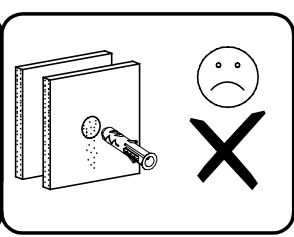
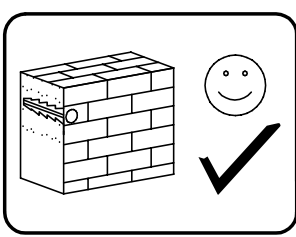
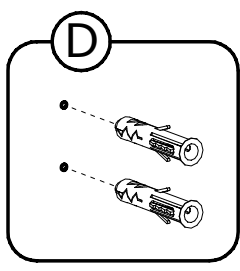
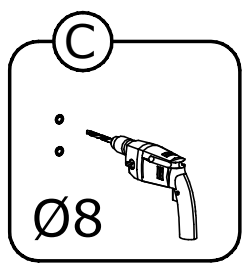
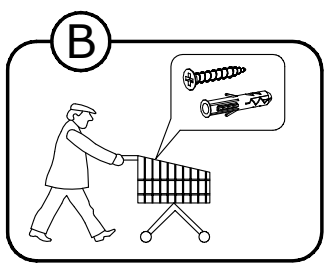
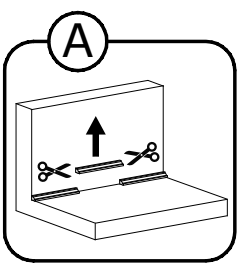
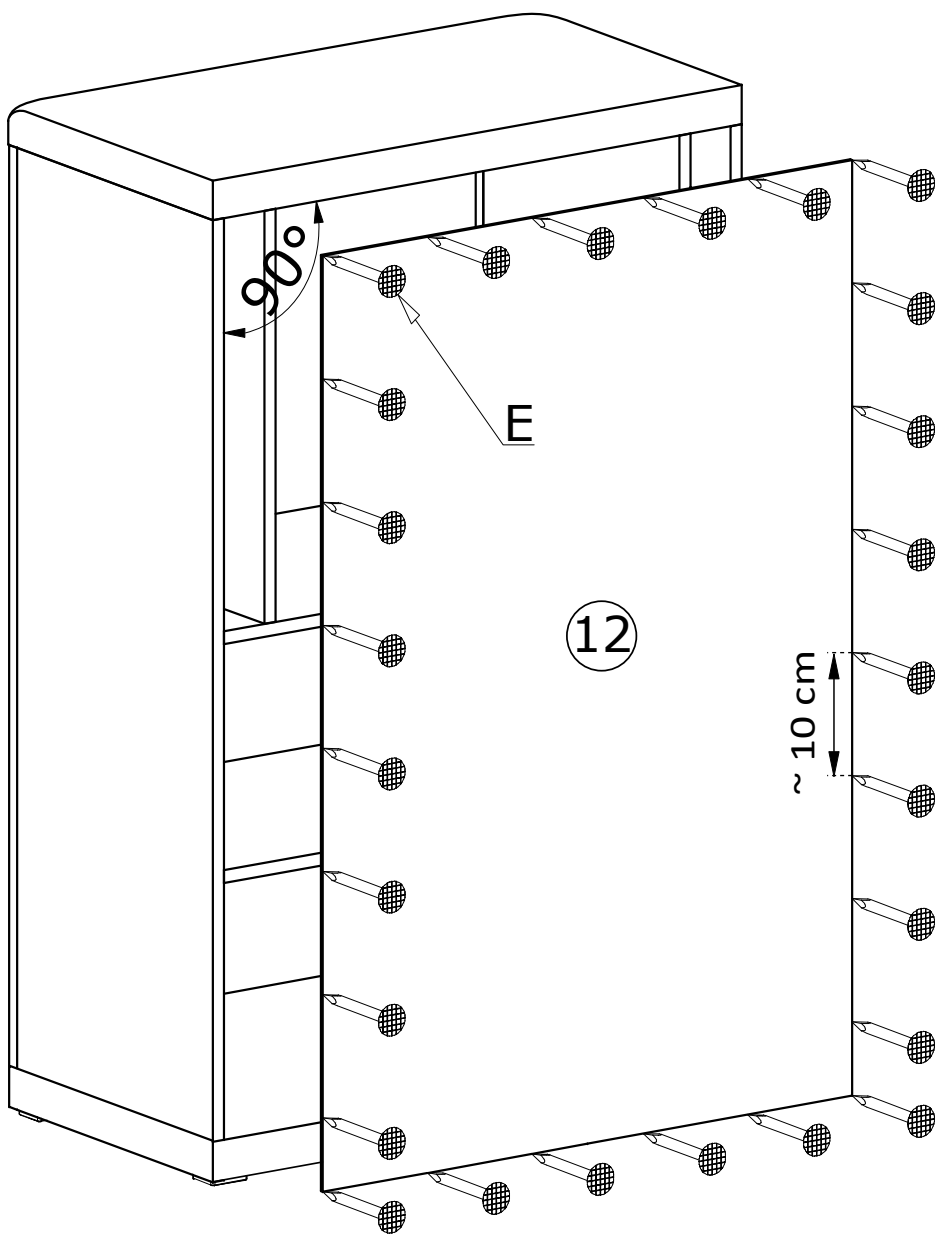

V

