

# DALLAS 2

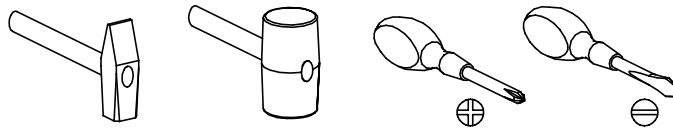

Narzędzia potrzebne do montażu



## UWAGA !!!

MONTOWANIE USZKODZONYCH  
ELEMENTÓW POWODUJE UTRATĘ  
GWARANCJI

Nr	D[mm]	S[mm]	G[mm]	Ilość
1	1070	450	48	1
2	1070	450	48	1
3	1030	25	16	2
4	800	422	16	1
5	800	422	16	1
6	800	100	32	1
7	800	100	32	1
8	800	405	16	1
9	800	405	16	1
10	1062	1056	2,5	1
11	826	405	2,5	4
12	872	190	16	4
13	400	150	16	4
14	400	150	16	4
15	796	150	16	4

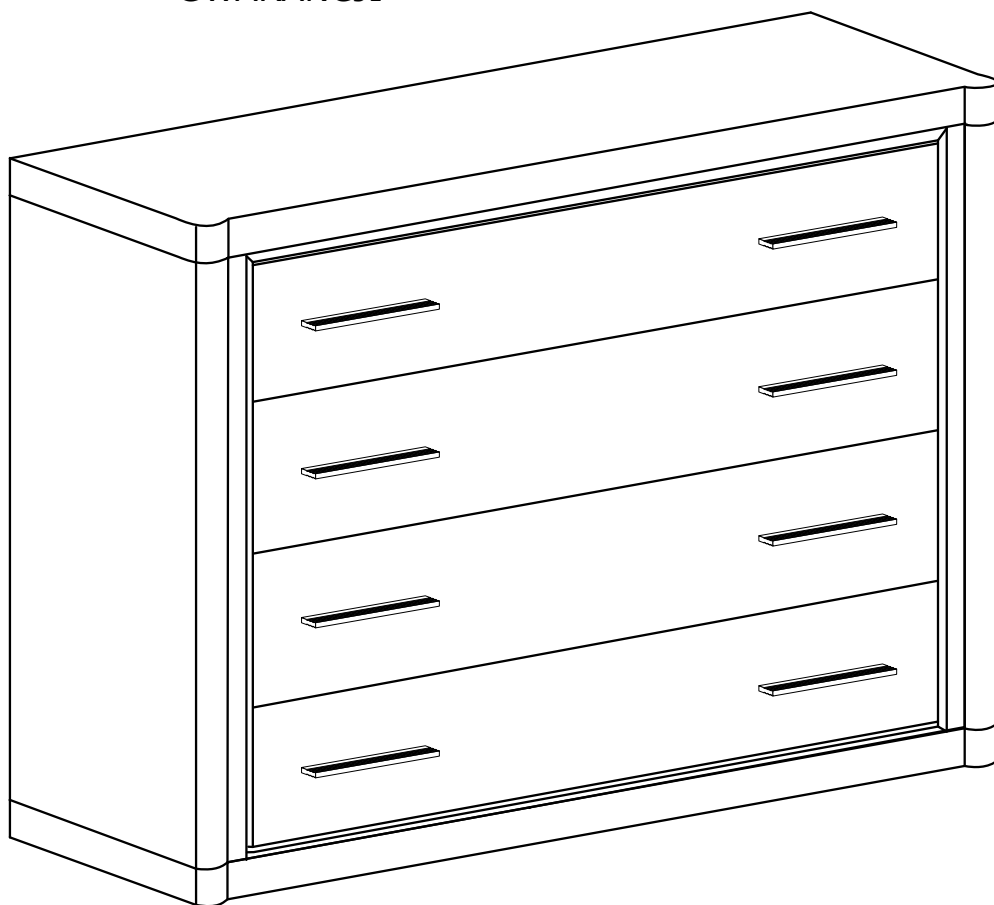

W przypadku reklamacji proszę podać numer pakowacza znajdujący się na kartonie.

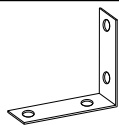

**Y - 2 St.**

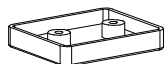

**A - 4 St.**

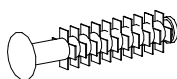

**F - 16 St.**

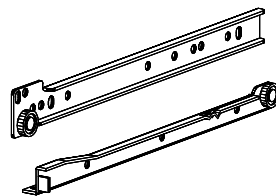

**T - 4 Kpl.**



**L - 14 St.**

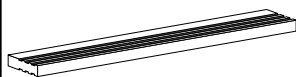

**U - 8 St.**

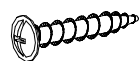

**N - 16 St.**  
4x30 mm

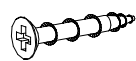

**M - 24 St.**  
4x25 mm

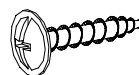

**I - 4 St.**  
3,5x16 mm



**S - 1 St.**



**E - 70 St.**



**B - 32 St.**

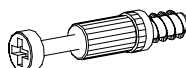

**K - 14 St.**

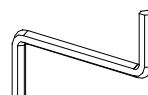

**Z - 1 St.**

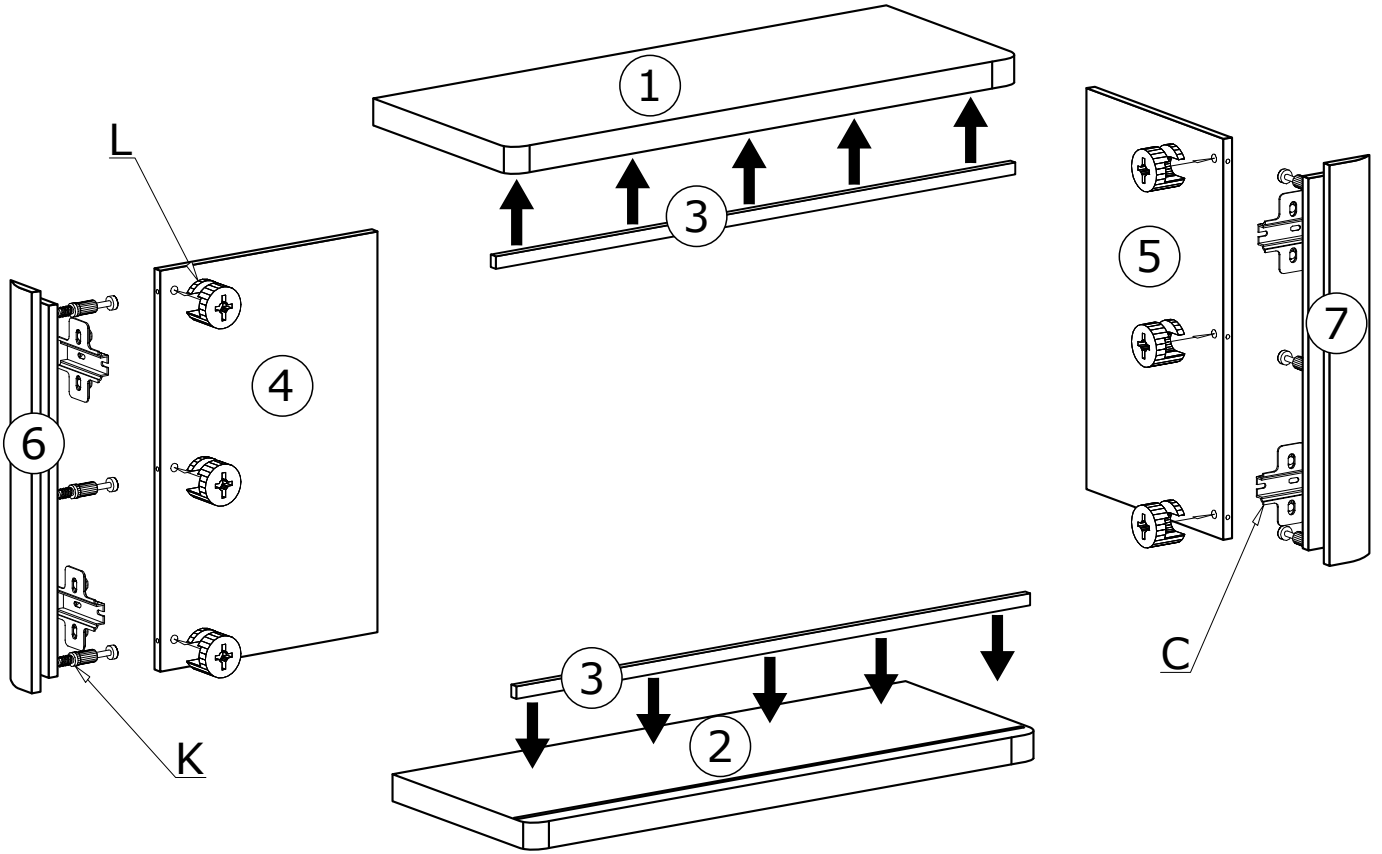
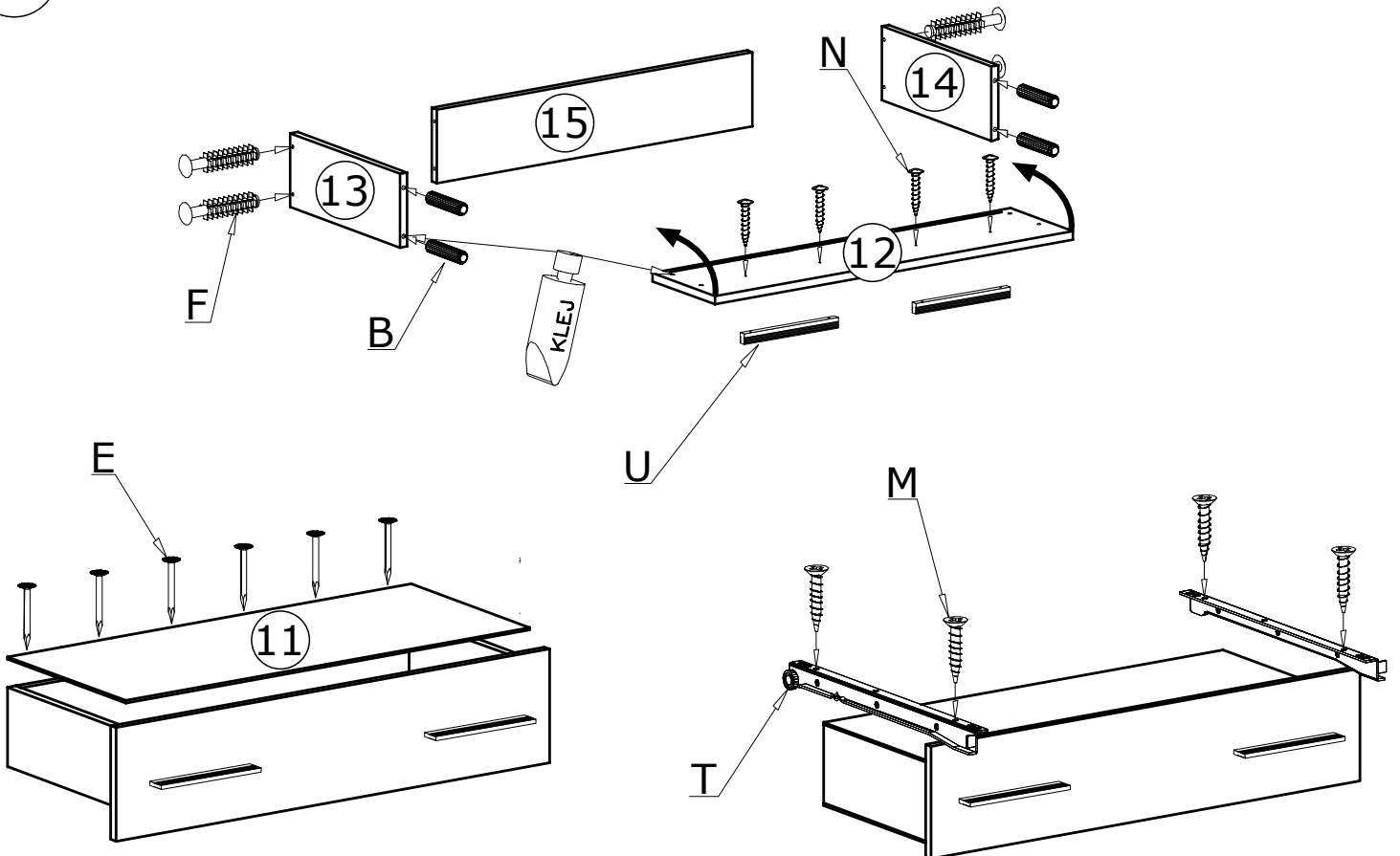

**J - 16 St.**  
5x13 mm

**I****II**

III

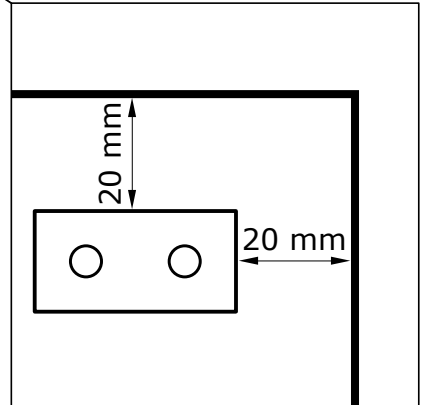
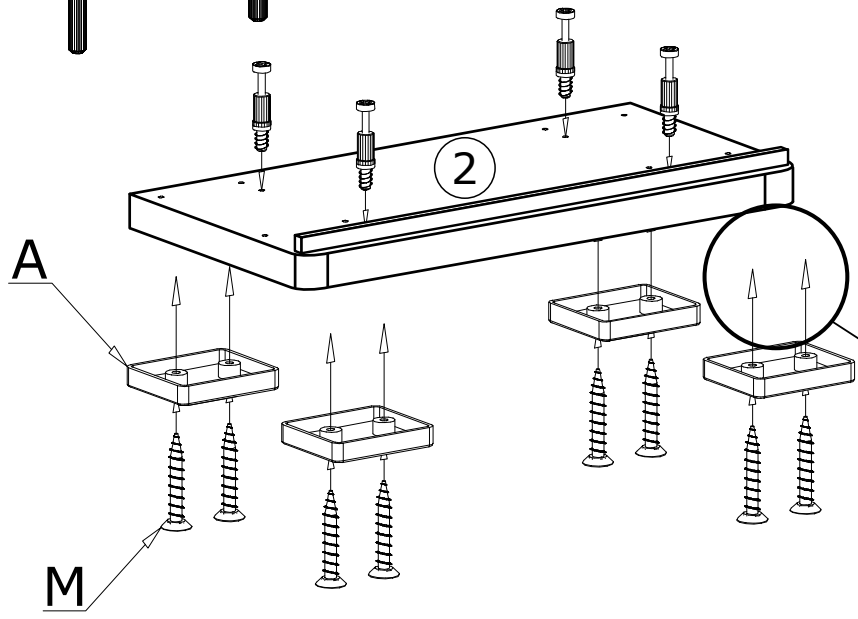
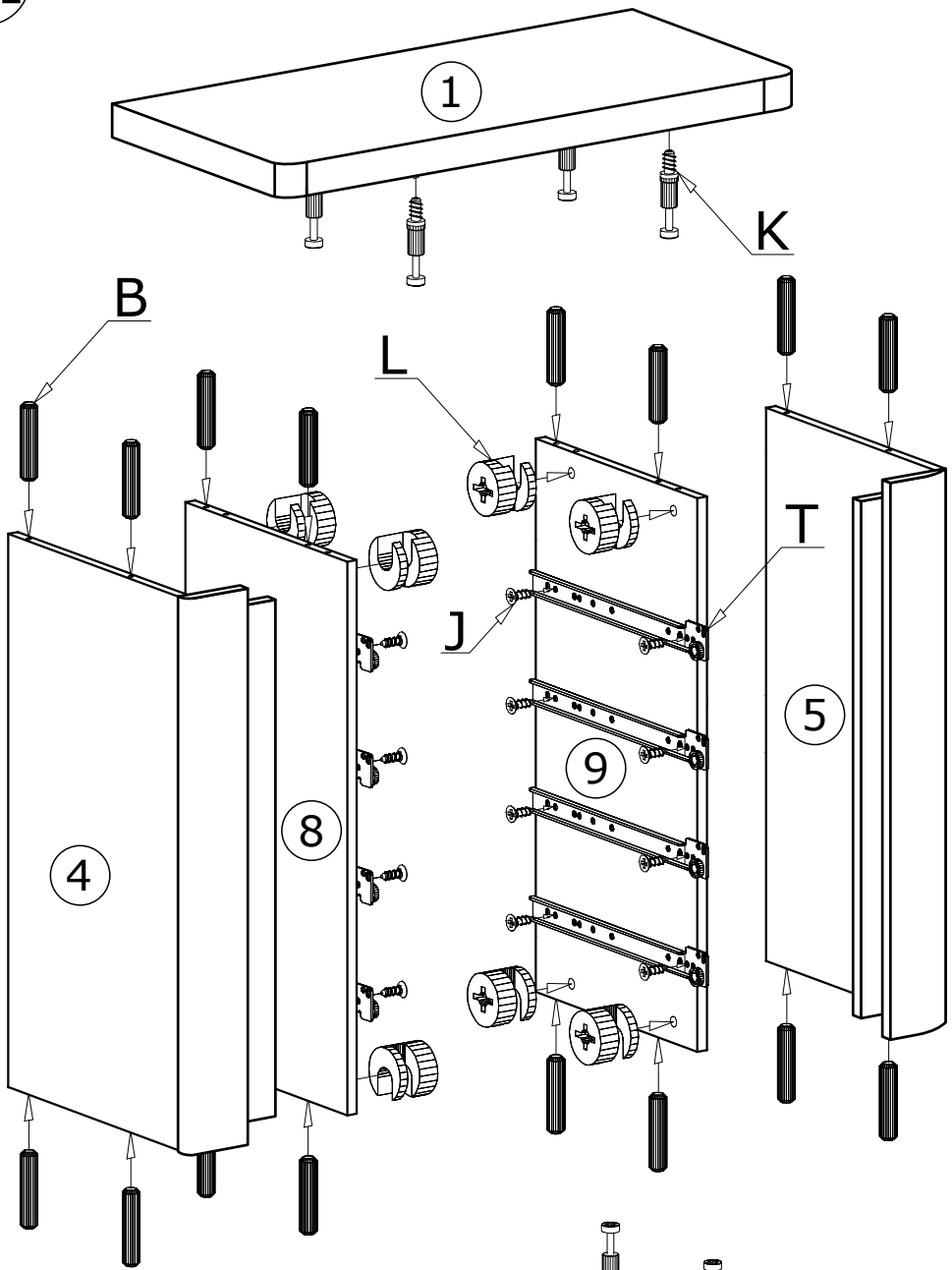

IV

70X 

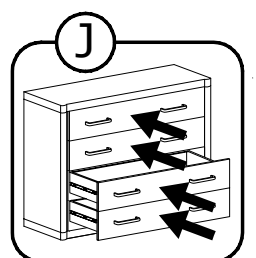
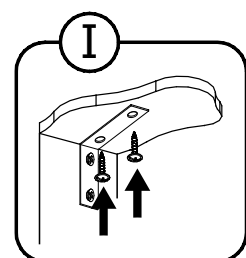
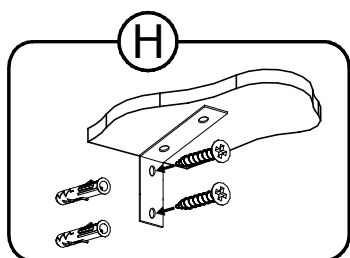
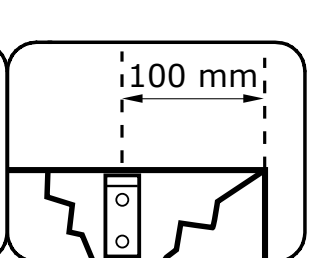
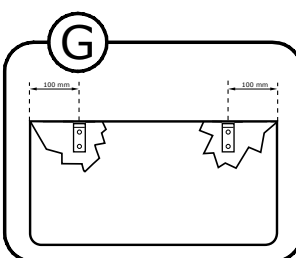
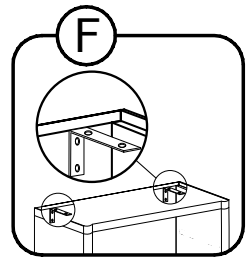
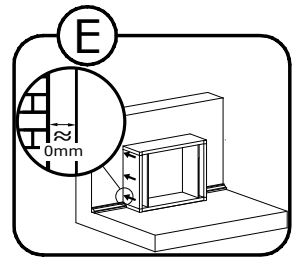
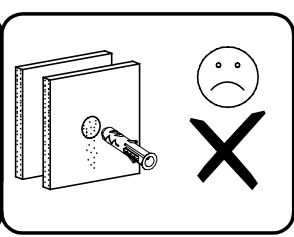
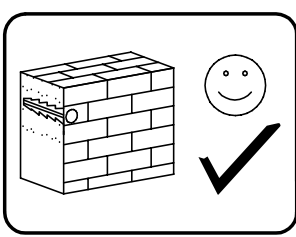
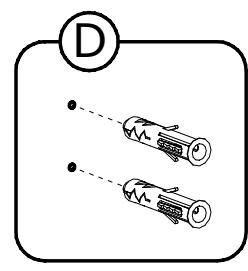
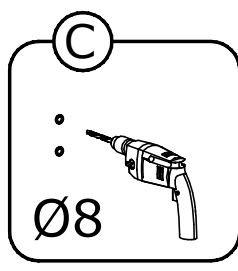
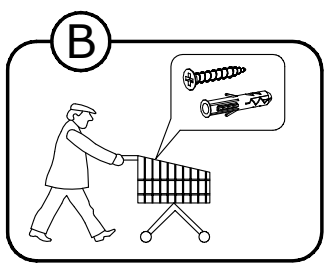
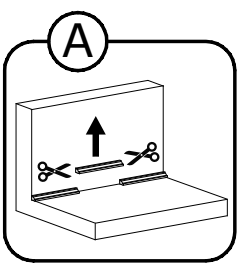
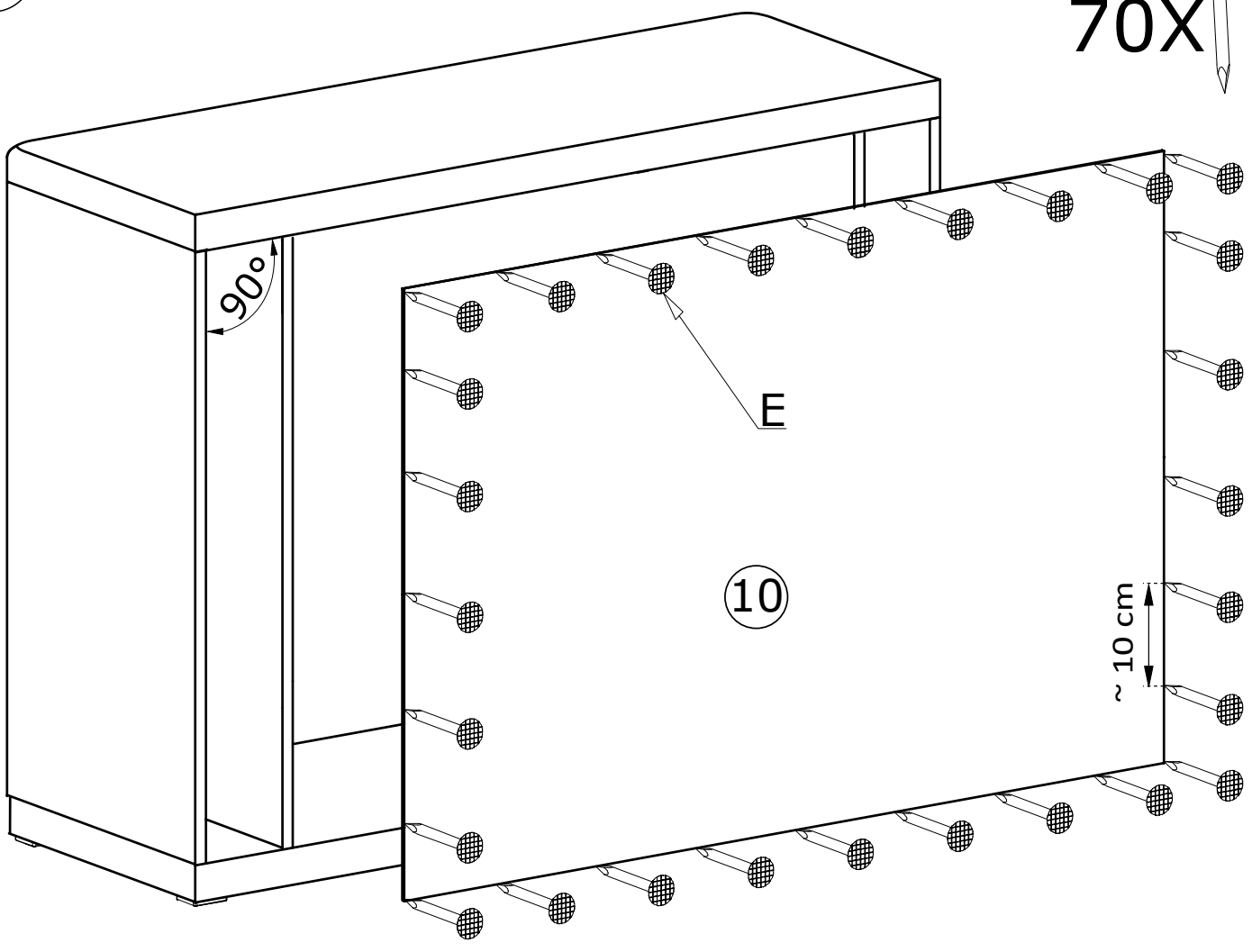

V

