

# DALLAS 1

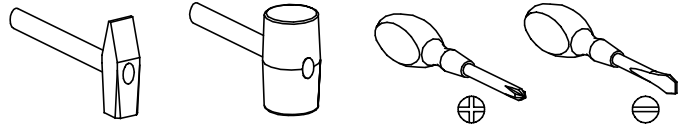

Narzędzia potrzebne do montażu



## UWAGA !!!

MONTOWANIE USZKODZONYCH  
ELEMENTÓW POWODUJE UTRATĘ  
GWARANCJI

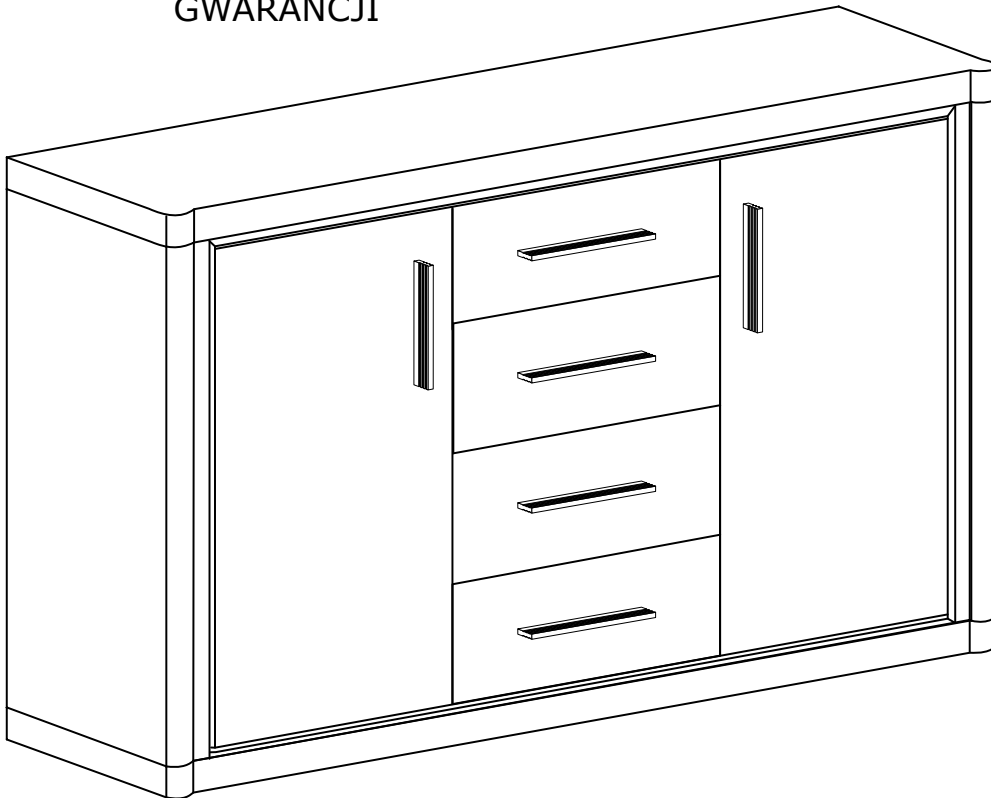

Nr	D[mm]	S[mm]	G[mm]	Ilość
1	1570	450	48	1
2	1570	450	48	1
3	1530	25	16	2
4	800	422	16	1
5	800	422	16	1
6	800	100	32	1
7	800	100	32	1
8	835	405	16	1
9	835	405	16	1
10	440	380	16	2
11	1560	856	2,5	1
12	636	190	16	4
13	400	150	16	4
14	400	150	16	4
15	560	150	16	4
16	590	405	2,5	4
17	772	365	16	1
18	772	365	16	1

W przypadku reklamacji proszę podać numer pakowacza znajdujący się na kartonie.

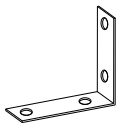

**Y - 2 St.**

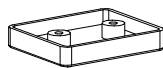

**A - 6 St.**



**M - 28 St.**  
4x25 mm

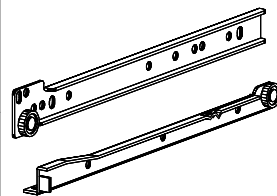

**T - 4 Kpl.**

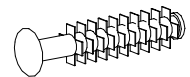

**F - 16 St.**

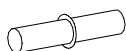

**P - 8 St.**



**N - 12 St.**  
4x30 mm

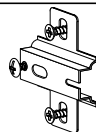

**C - 4 St.**



**L - 22 St.**

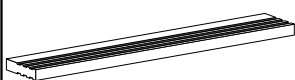

**U - 6 St.**



**G - 8 St.**  
3,5x16 mm

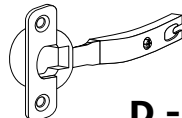

**D - 4 St.**



**I - 4 St.**  
3,5x16 mm



**S - 1 St.**



**E - 90 St.**



**B - 32 St.**

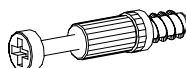

**K - 22 St.**

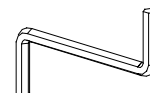

**Z - 1 St.**



**J - 16 St.**  
5x13 mm

# I

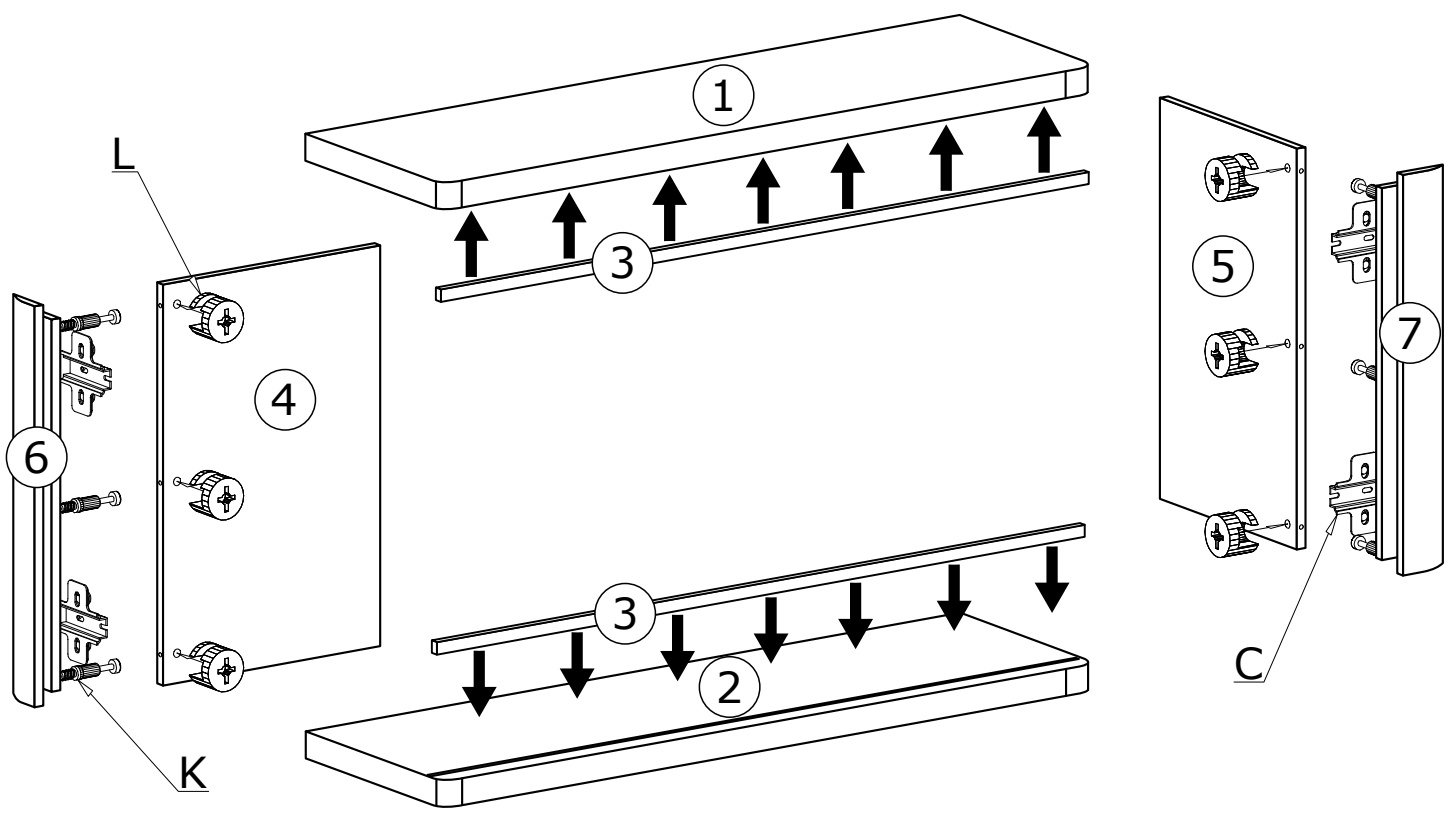

# II

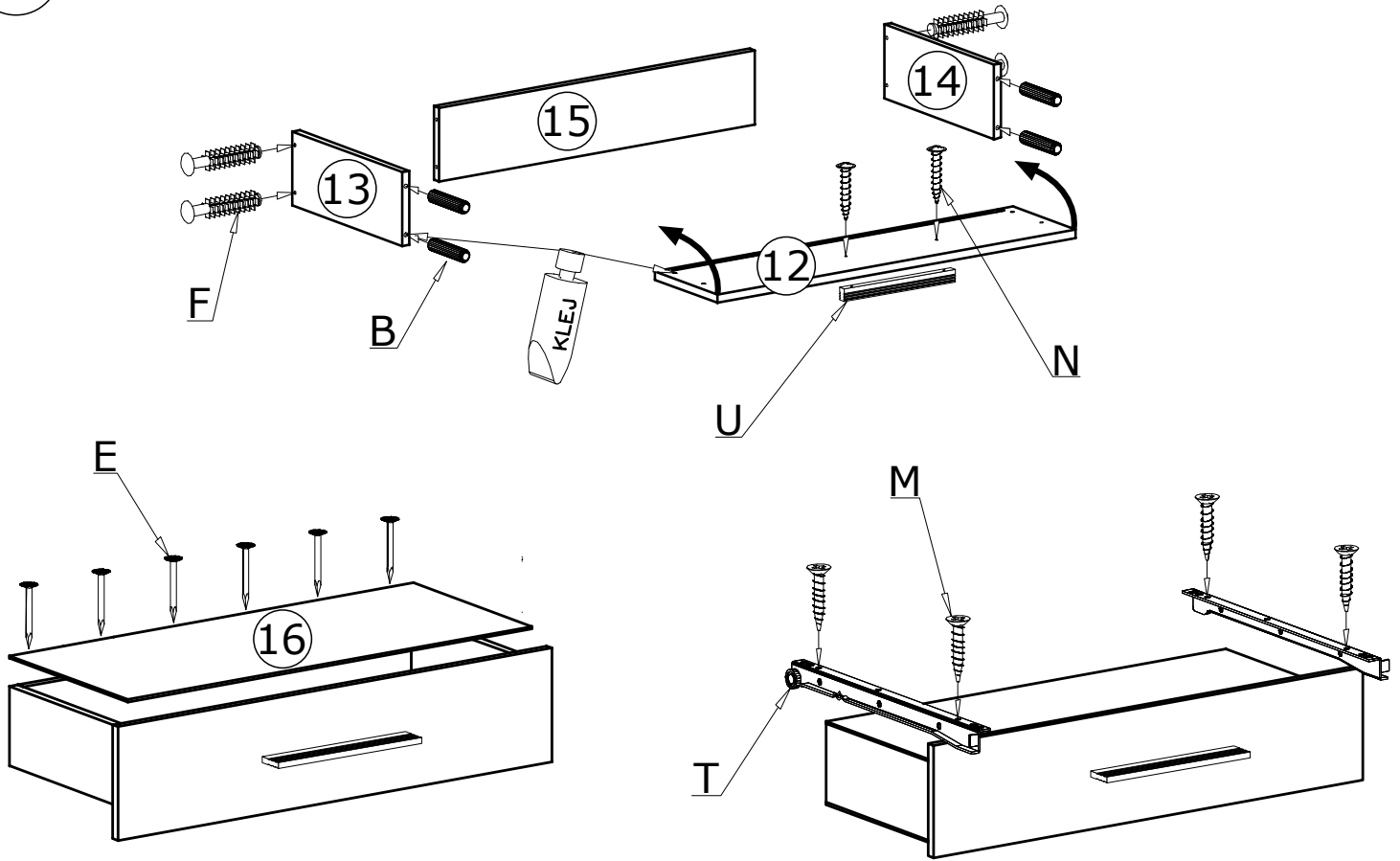

III

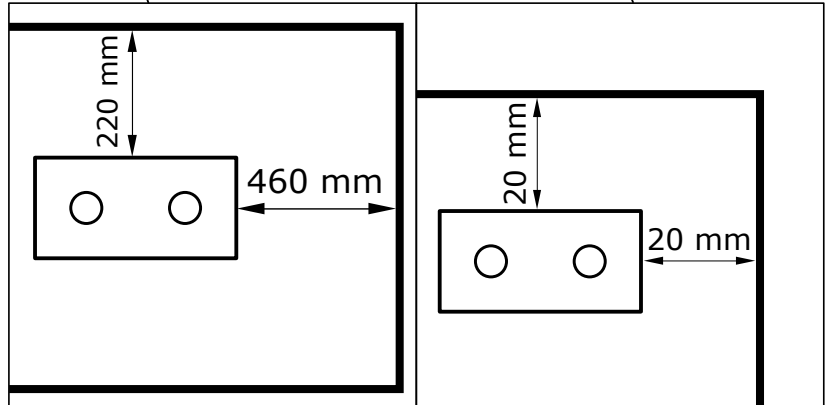
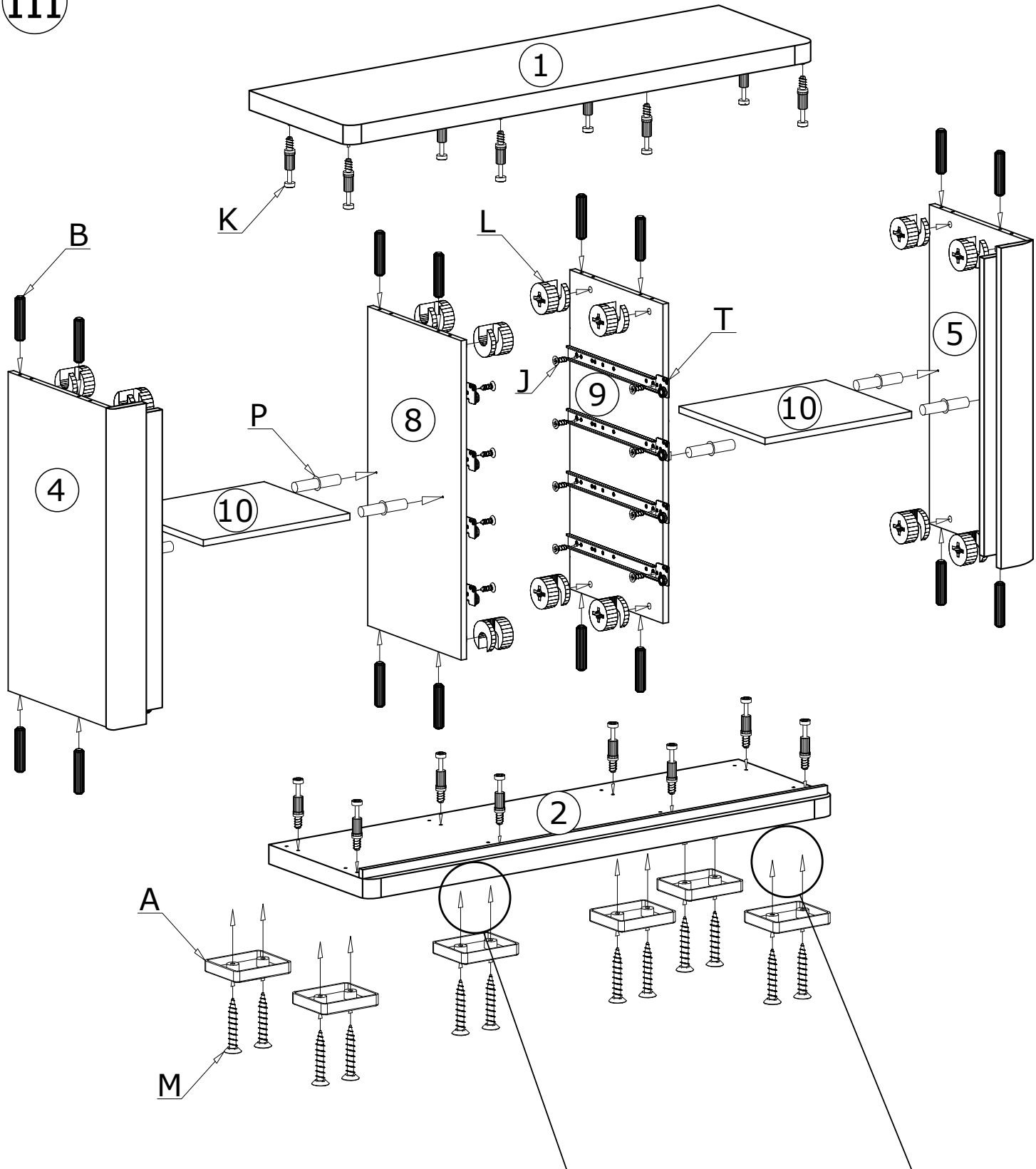

IV

70X 

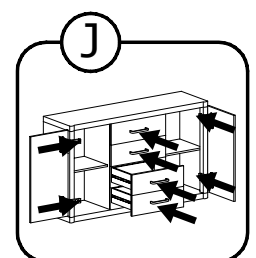
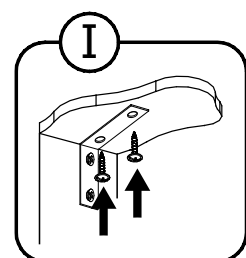
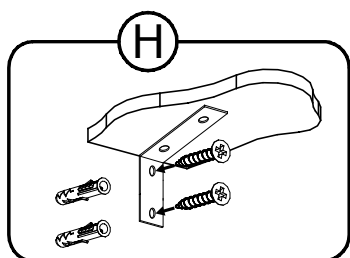
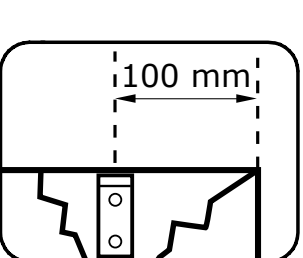
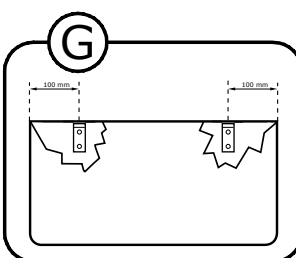
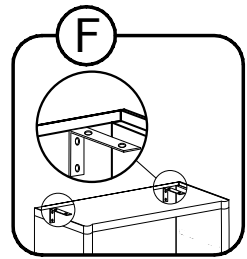
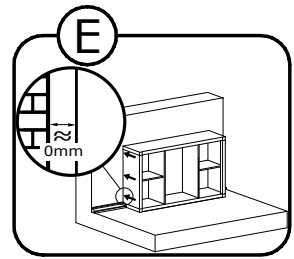
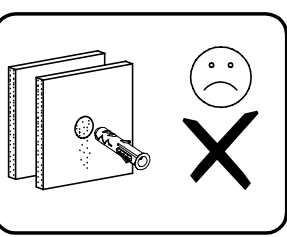
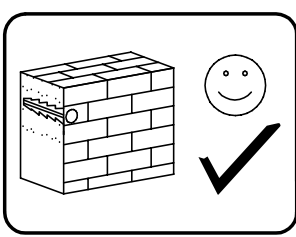
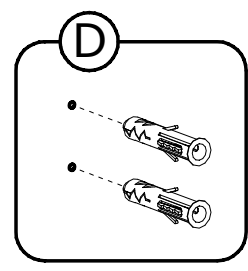
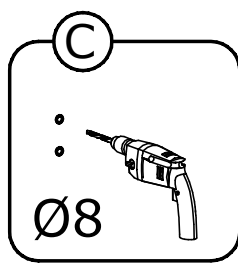
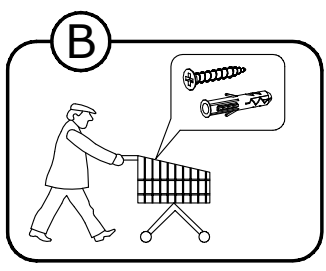
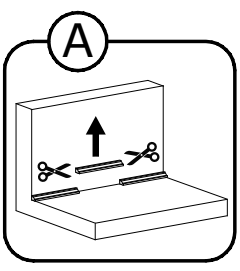
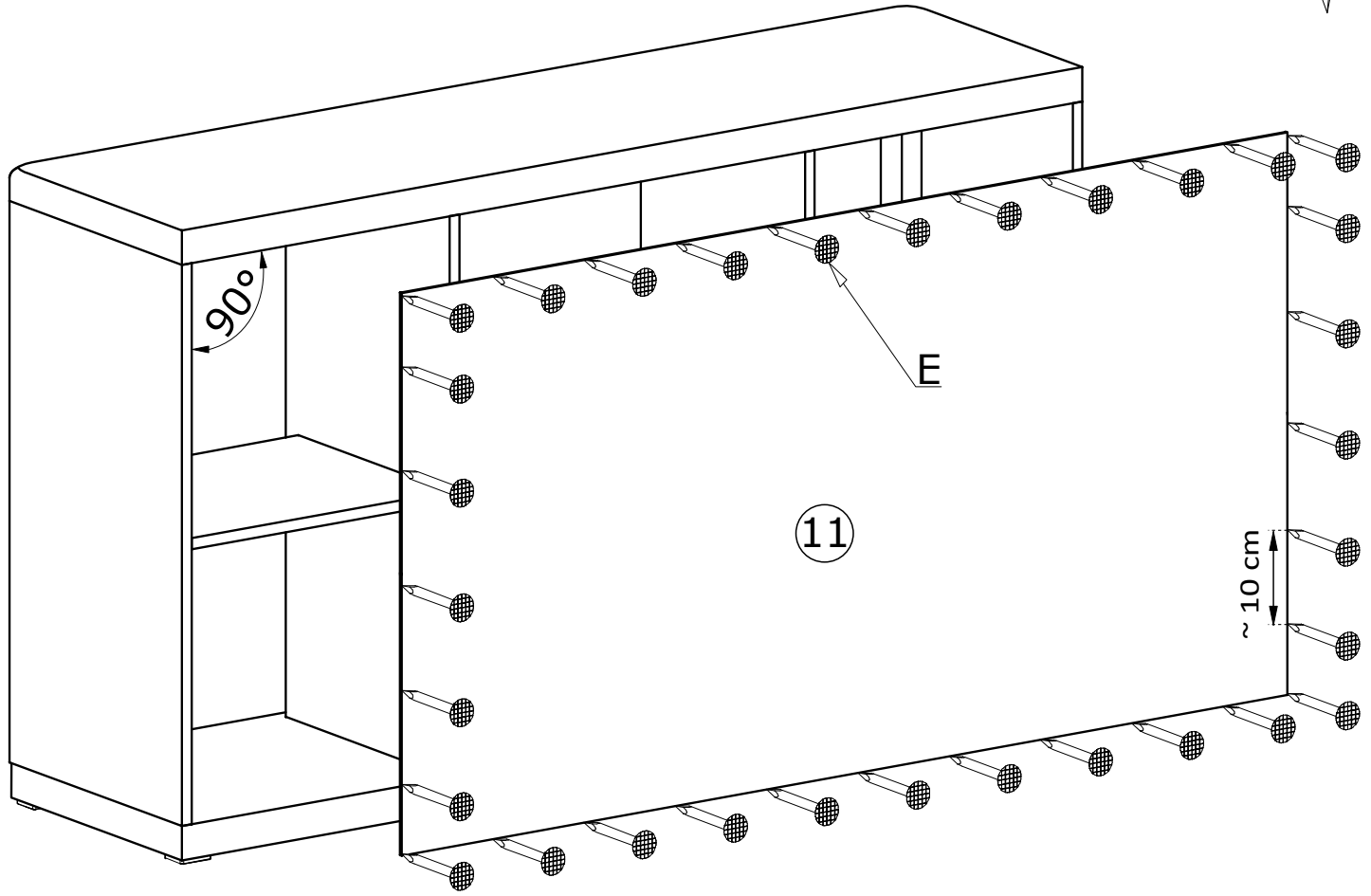

V

