

# KORA 7

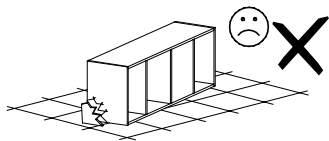

Narzędzia potrzebne do montażu

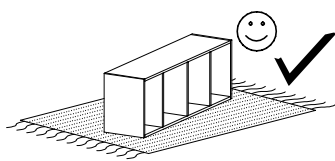
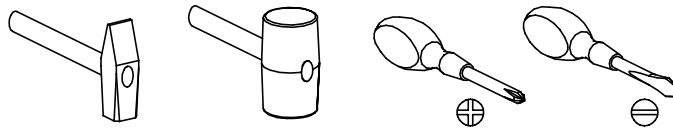

## UWAGA !!!

MONTOWANIE USZKODZONYCH  
ELEMENTÓW POWODUJE UTRATĘ  
GWARANCJI

Nr	D[mm]	S[mm]	G[mm]	Ilość
1	1607	450	65	1
2	1607	450	65	1
3	830	410	16	1
4	830	410	16	1
5	830	410	16	1
6	830	410	16	1
7	1537	852	2,5	1
8	432	380	16	2
9	770	450	16	1
10	770	450	16	1
11	635	190	16	4
12	350	150	16	4
13	350	150	16	4
14	560	150	16	4
15	590	355	2,5	4

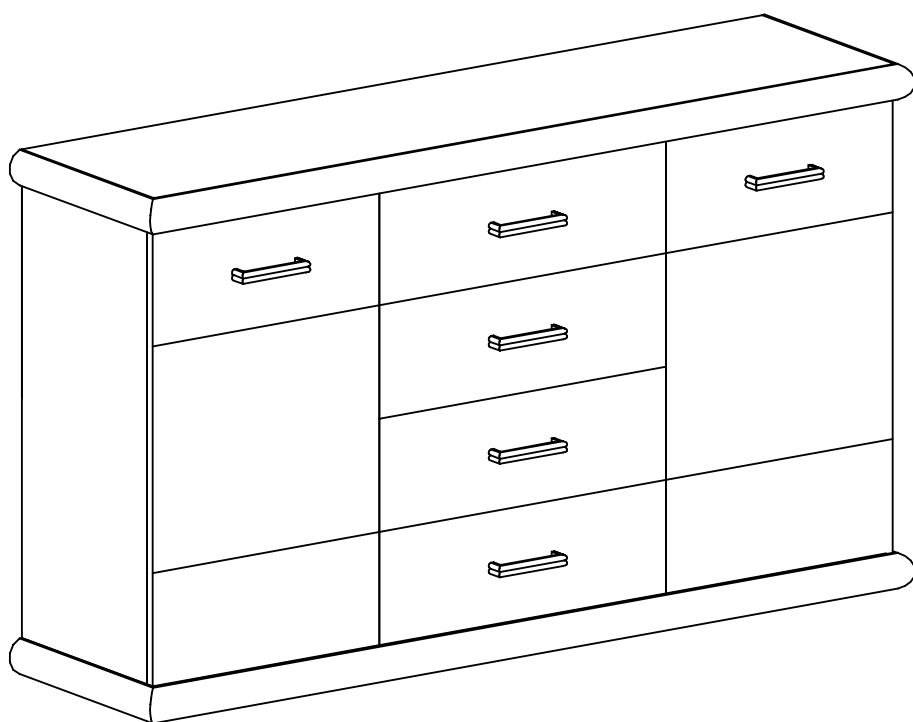

## UWAGA !!!

Mebel zawiera  
elementy drewniane

W przypadku reklamacji proszę podać numer pakowacza znajdujący się na kartonie.



**I - 8 St.**

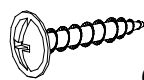

**Q - 4 St.**  
3,5x16 mm

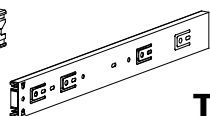
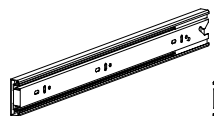

**T - 4 Kpl.**

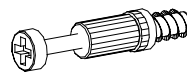

**K - 24 St.**

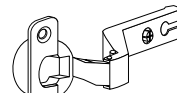

**D - 4 St.**

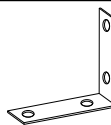

**Y - 2 St.**



**J - 32 St.**  
5x13 mm



**M - 60 St.**  
3x30 mm



**F - 5 St.**

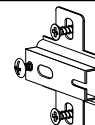

**C - 4 St.**



**S - 8 St.**



**Z - 1 St.**



**U - 6 St.**

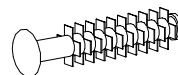

**P - 16 St.**



**N - 12 St.**  
4x27 mm



**E - 70 St.**



**B - 32 St.**



**G - 28 St.**  
3,5x16 mm

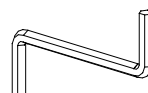

**Z - 1 St.**



**L - 24 St.**

I

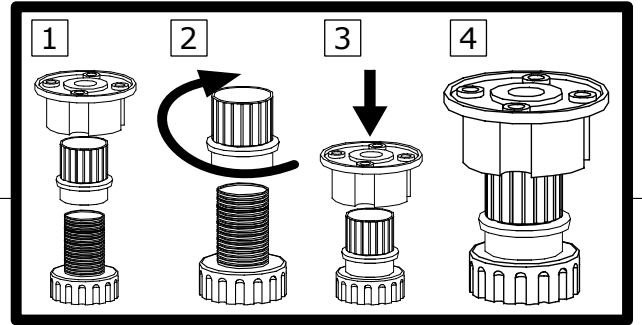
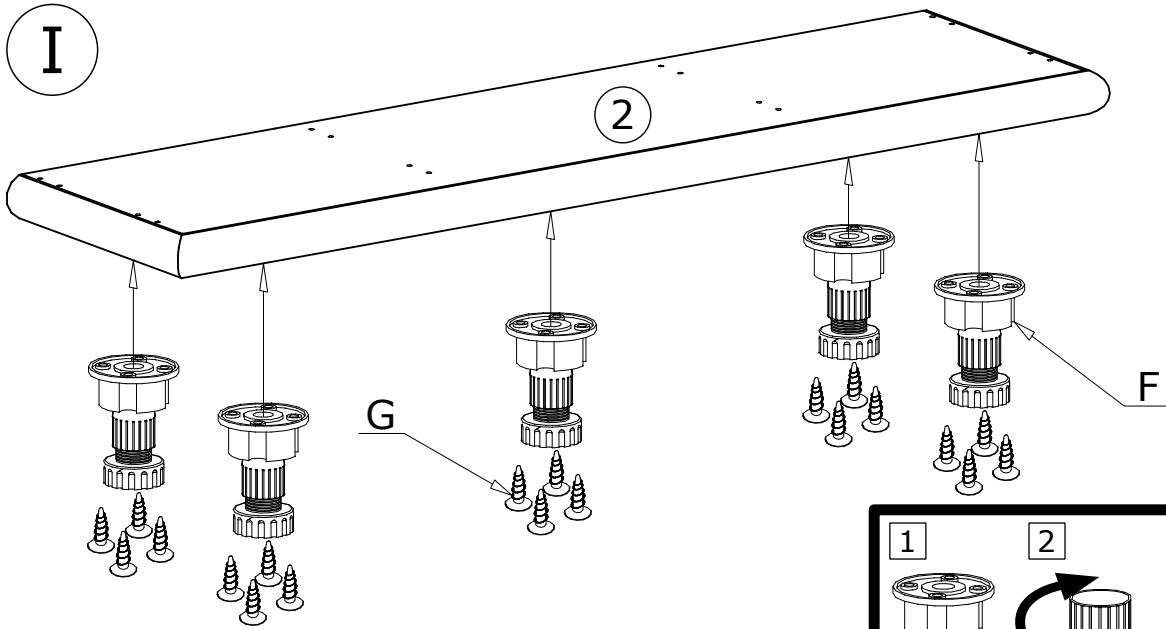

II

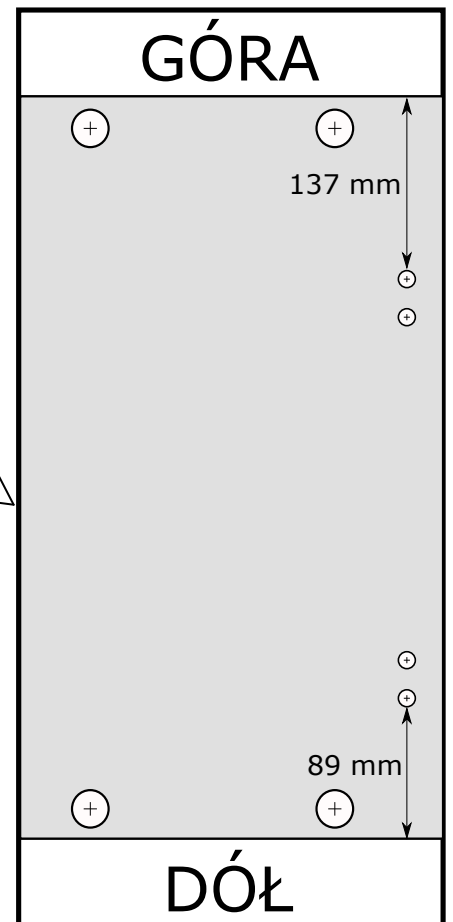
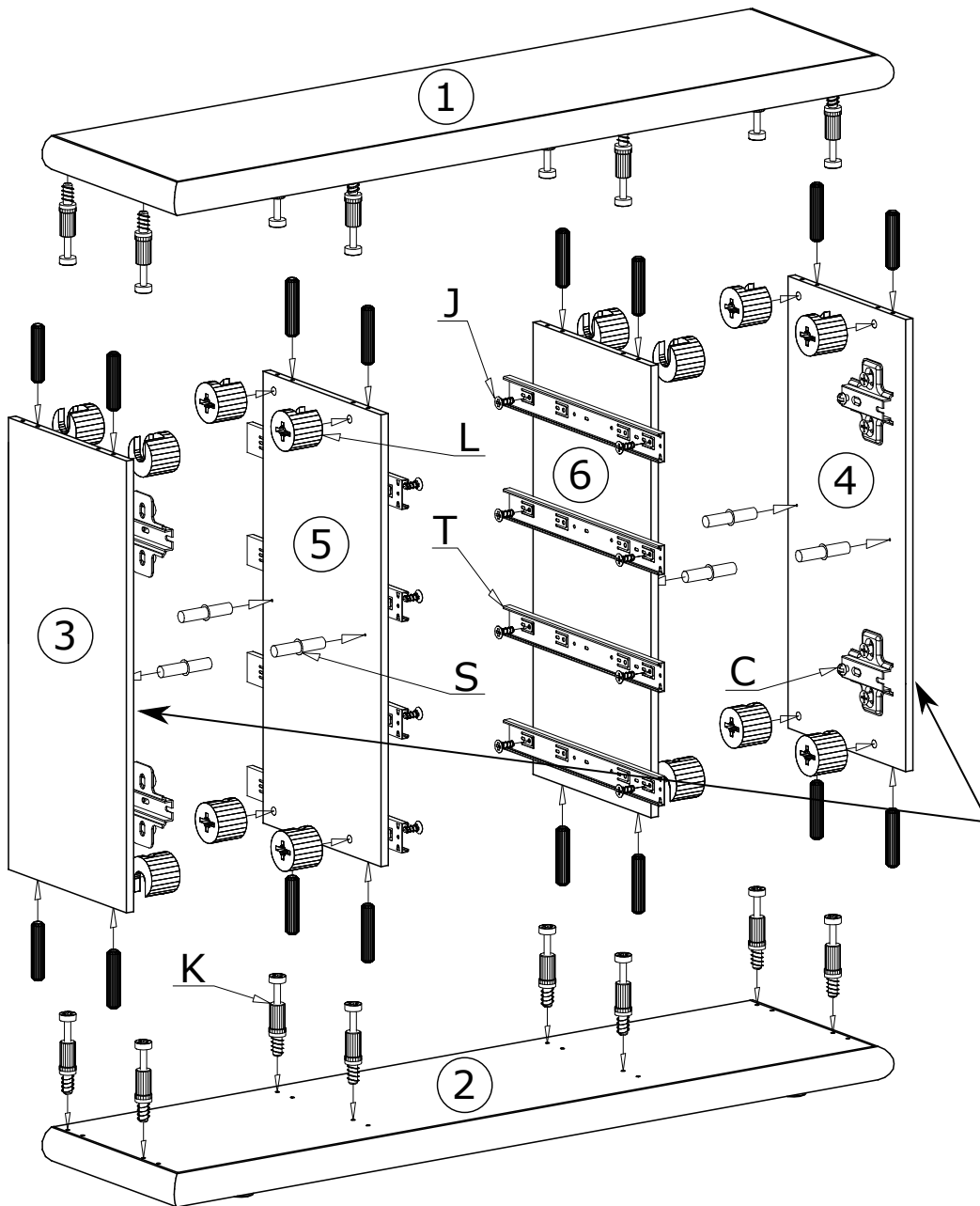

III

70X 

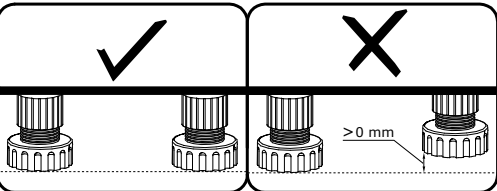
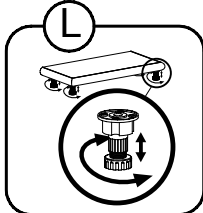
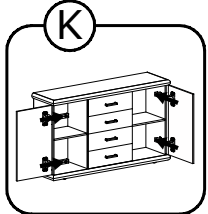
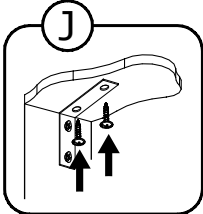
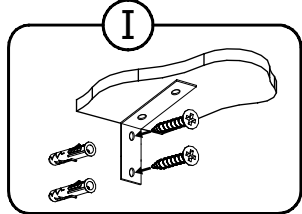
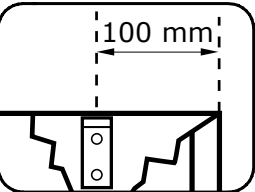
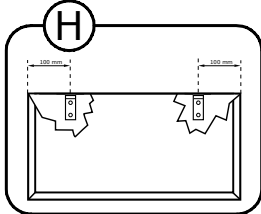
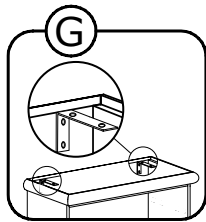
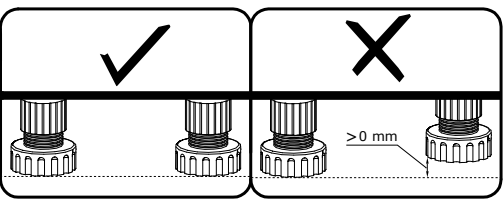
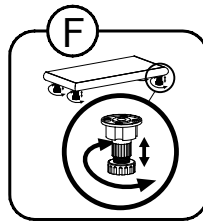
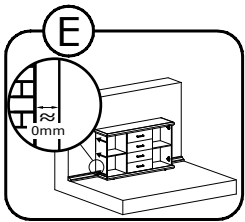
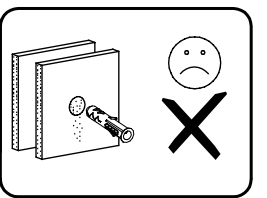
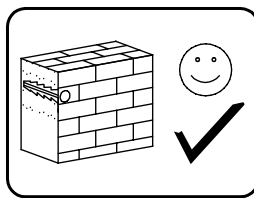
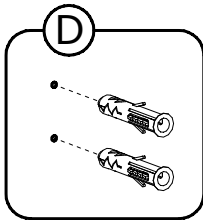
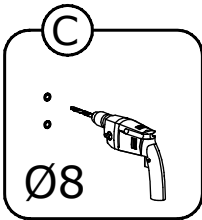
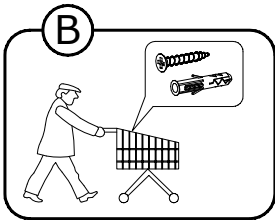
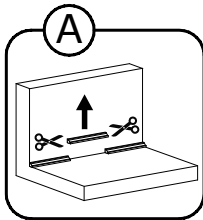
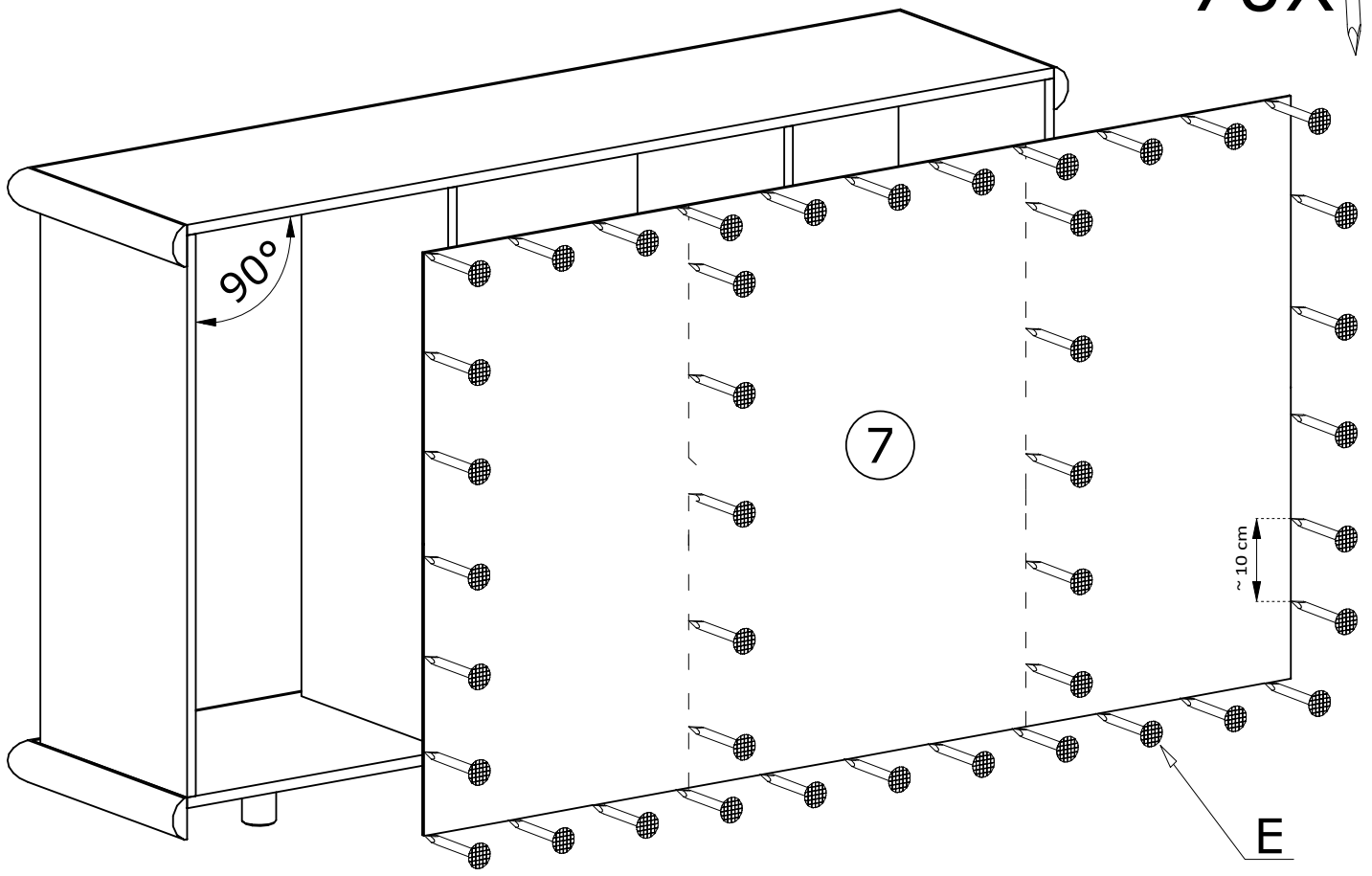

IV

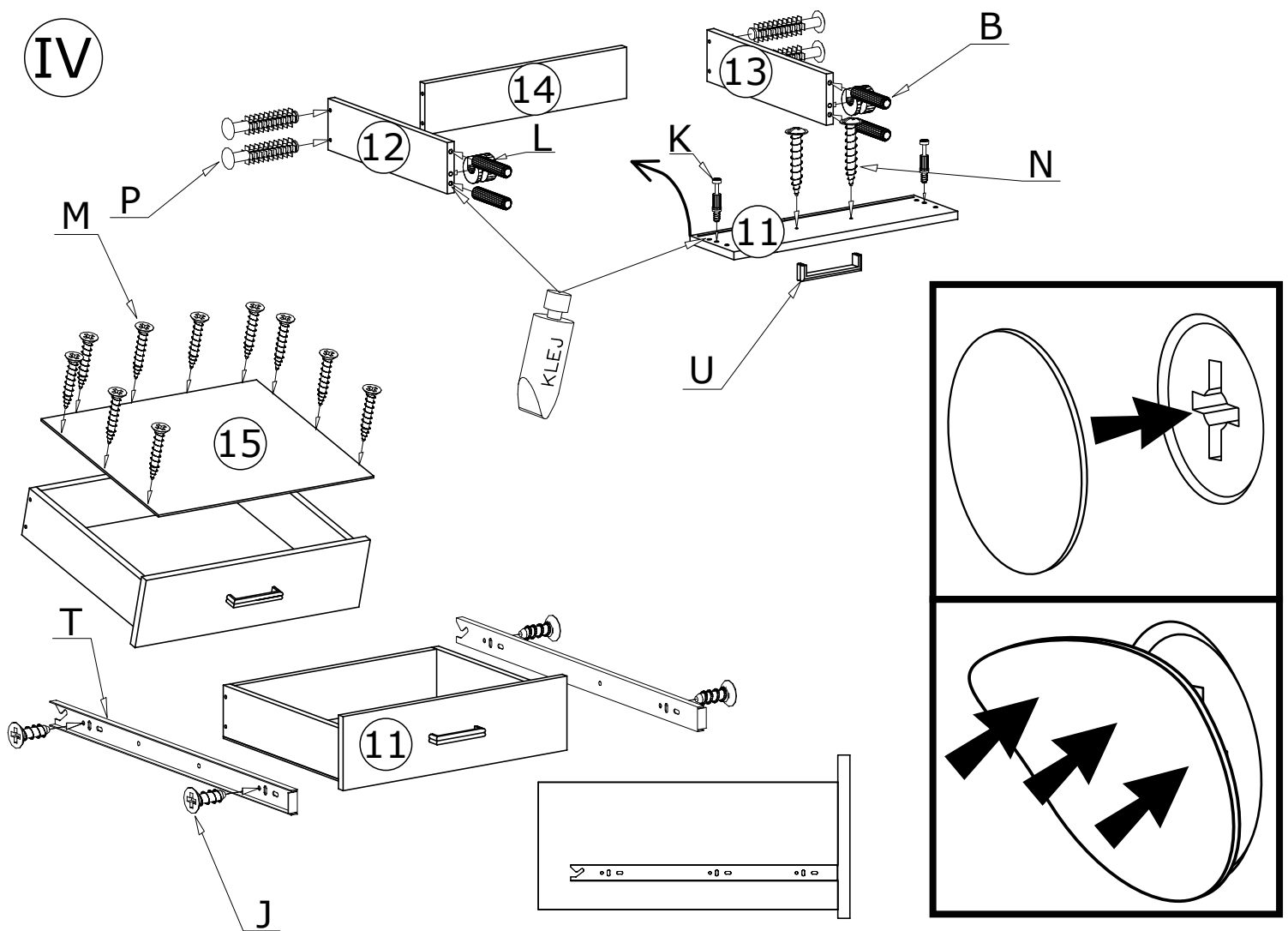

V

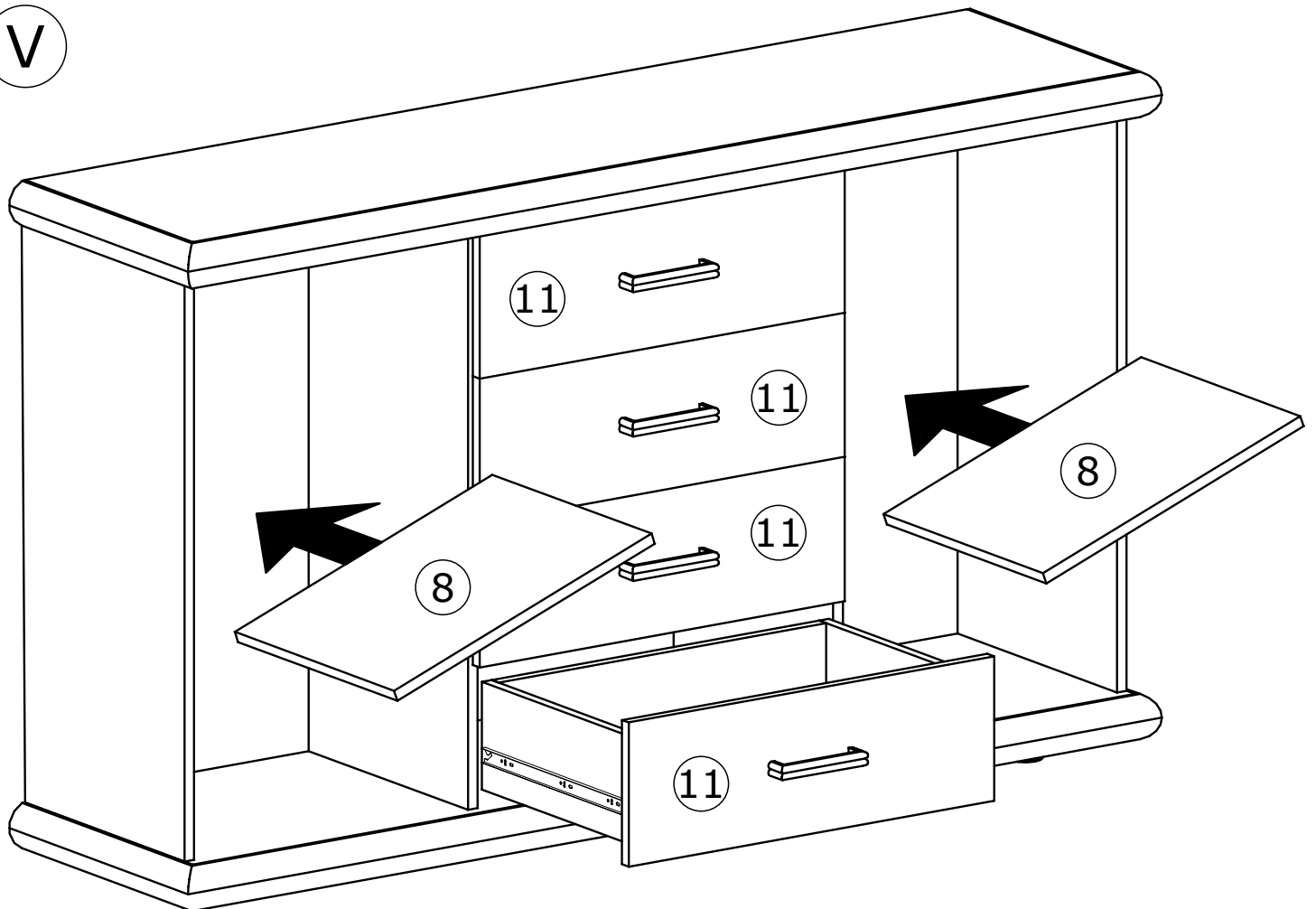

VI

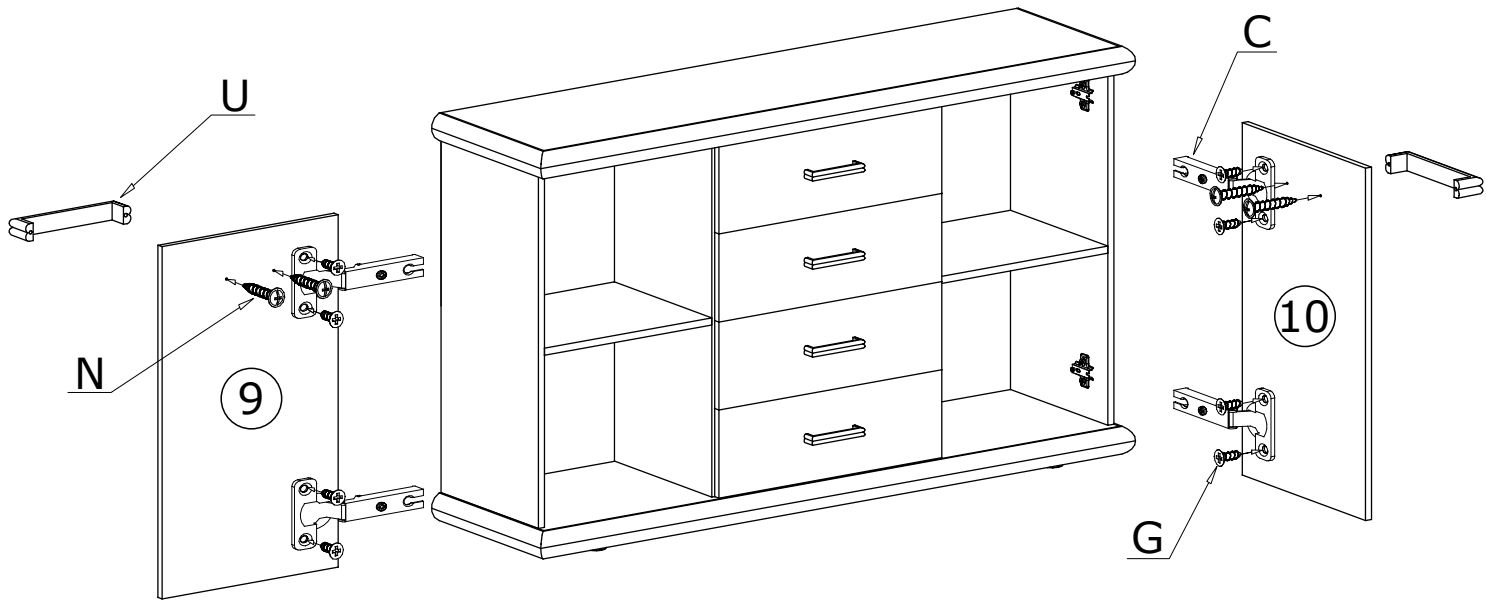

Meble zawierają elementy drewniane, których barwa i układ słoju są uzależnione od wielu czynników, dlatego mogą występować różnice w fakturze i barwie co nie stanowi wady produktu i nie wpływa na jego jakość, trwałość i funkcjonalność.

Listwy drewniane mogą ujawniać niewielkie zmiany w kształcie i wymiarach wywołane specyficznymi warunkami eksploatacji takimi jak: wilgotność, różnice temperatur, etc.

# MONTAŻ/DEMONTAŻ PROWADNIC

1



2



3

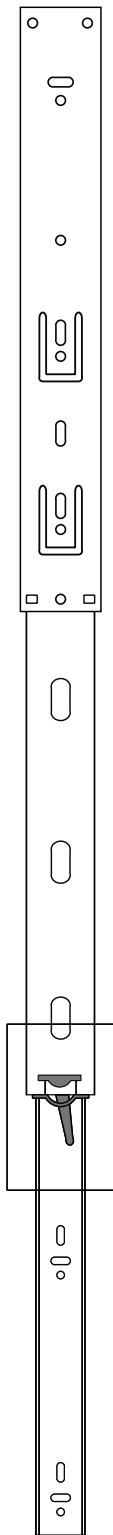

4

