

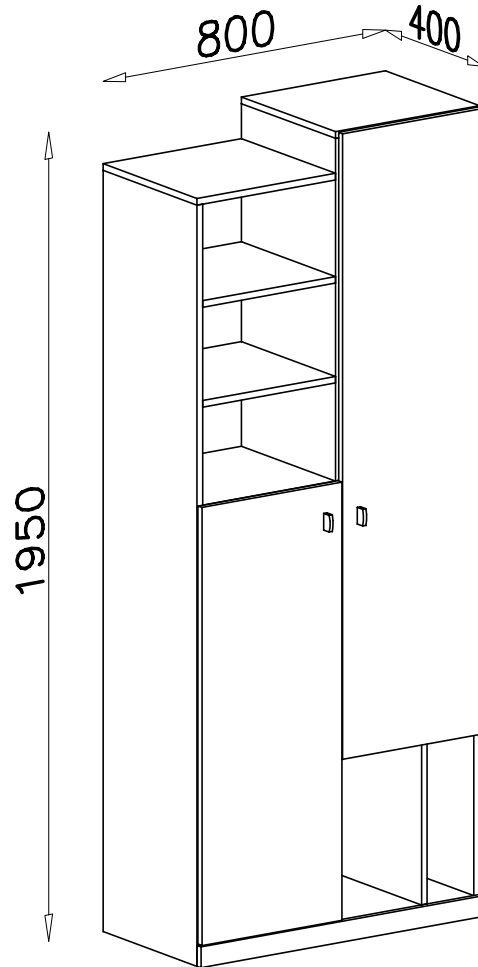

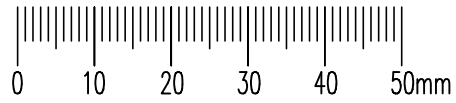

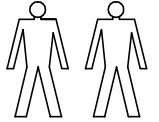

# TABLO TA 4

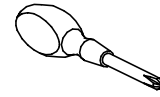
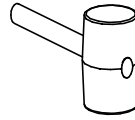
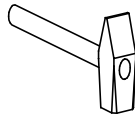
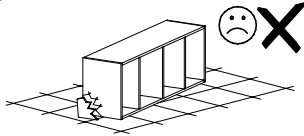
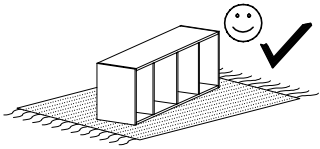
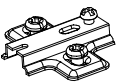
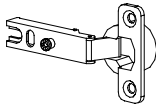
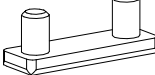

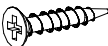
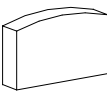
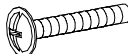

<b>F</b>  x5	<b>D</b>  x5	<b>G</b>  x4
---	---	---

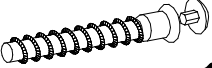
<b>W</b>  x2	<b>E</b>  3 x 20 x75	<b>U</b>  x2
---	--	---

<b>N</b>  M4 x 22 x4	<b>O</b>  x18
--	--

<b>A</b>  x13	<b>B</b>  x30	<b>P</b>  x28
---	--	--

<b>Z</b>  x1	<b>T</b>  4 x 16 x10
---	--

I

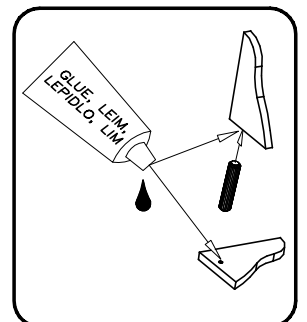
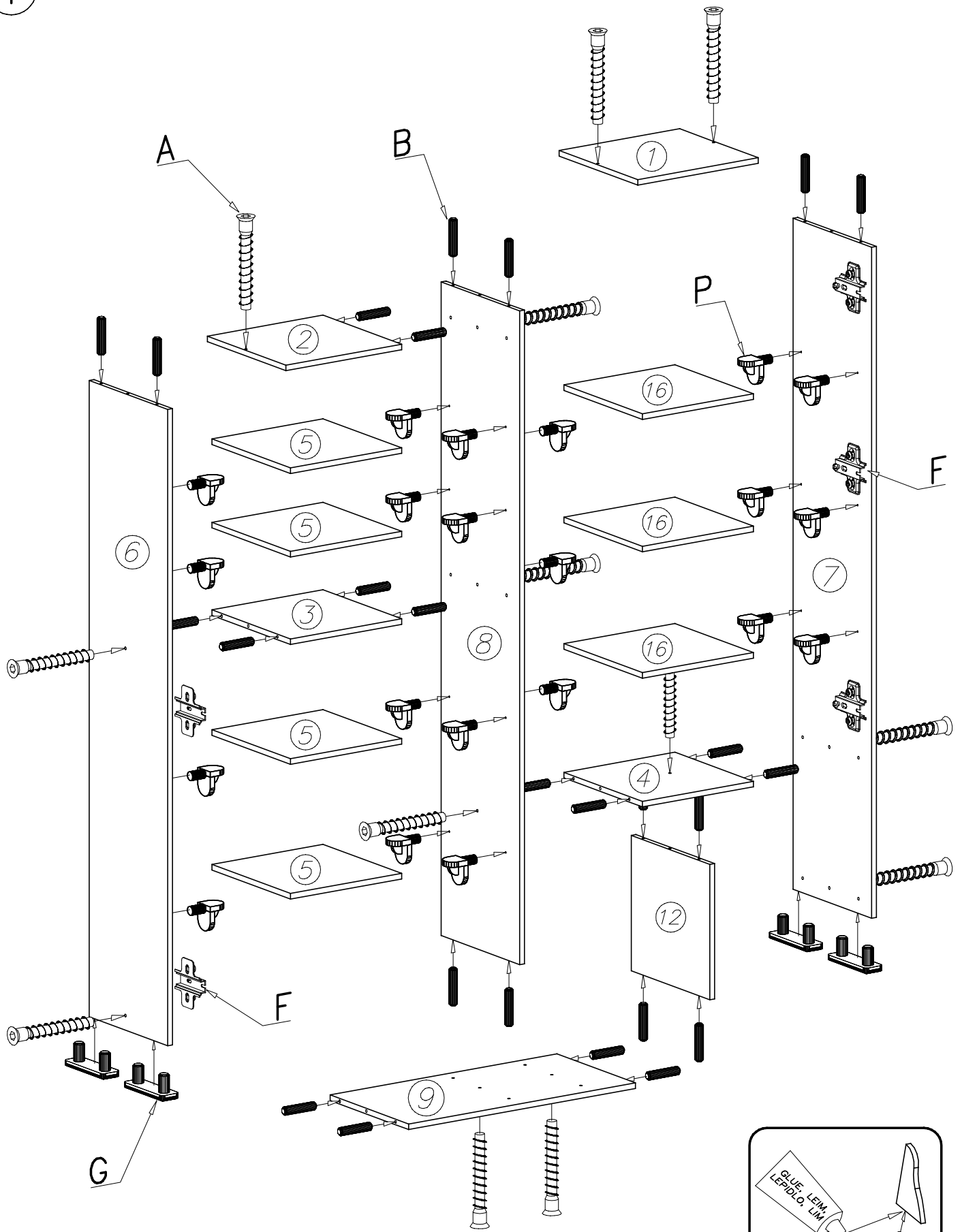

II

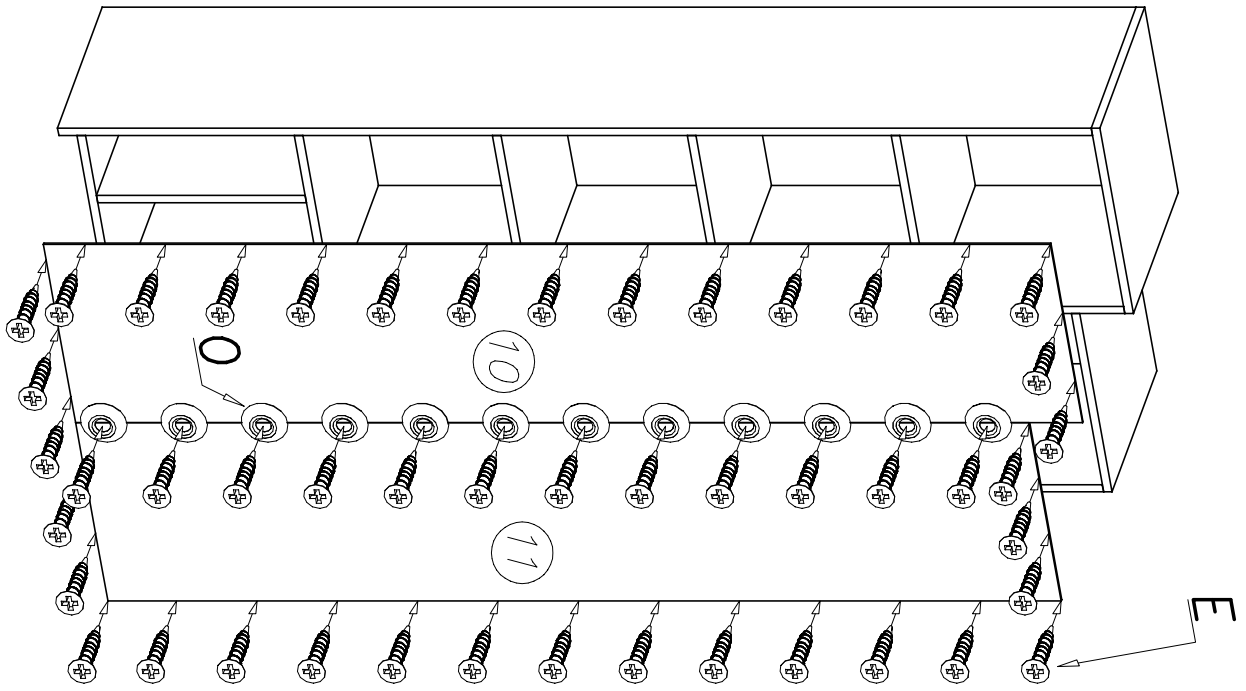

III

