

PL- Przed rozpoczęciem zapoznać się z instrukcją montażu/  
 DE- Vor die montage, bitte beiliegende anweisungen folgen/  
 EN- Before starting, refer to the assembling advice in annex/  
 CZ- Před zahájením naleznete v montážním návodu/  
 HR- Prije početka, uzmite upute za montažu u prilogu

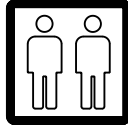

PL- Narzędzia niezbędne do montażu (nie dostarczone przez producenta)/ DE- Für die Montage notwendige Werkzeuge (nicht vom Hersteller mitgeliefert)/ EN- Tools required for assembly (not provided by the manufacturer)/ CZ- Nástroje nezbytné pro montáž (nejdou dodávány výrobcem)/ HR- Alat potreban za montažu (nije osiguran od strane proizvođača)

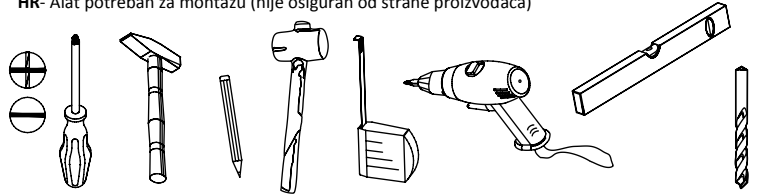

0 1 2 3 4 5 6 7



# L8

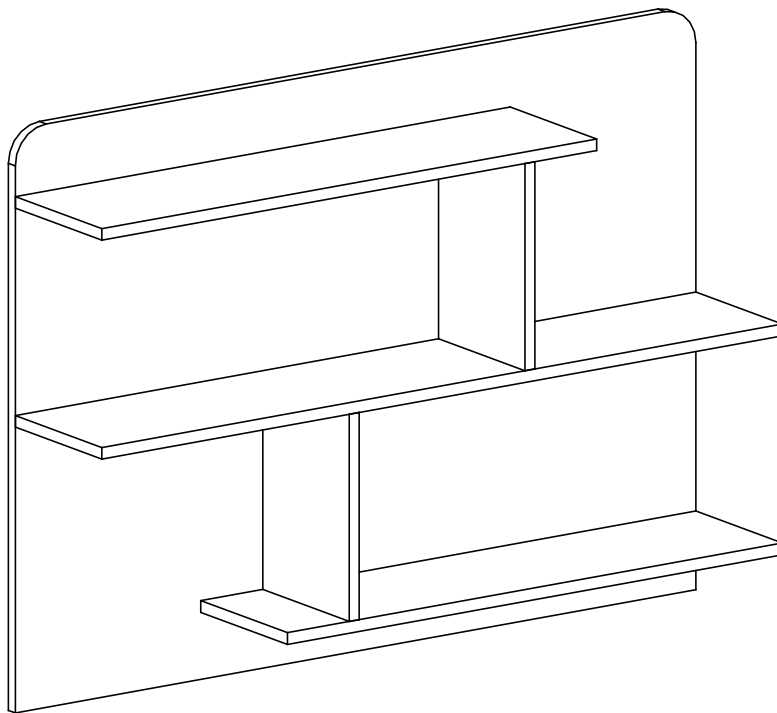

Nr	Xmm	Ymm	Zmm	Szt.
1	800	200	16	2
2	1100	200	16	1
3	1100	650	16	1
4	240	197	16	2

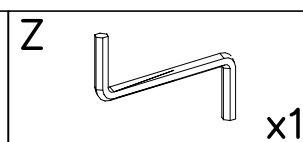
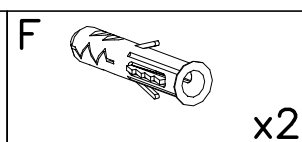
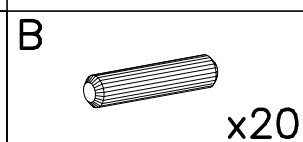
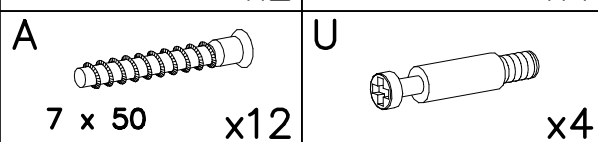
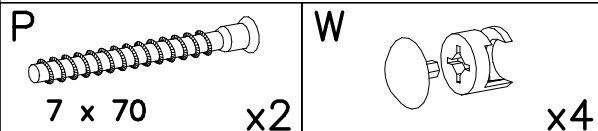

I

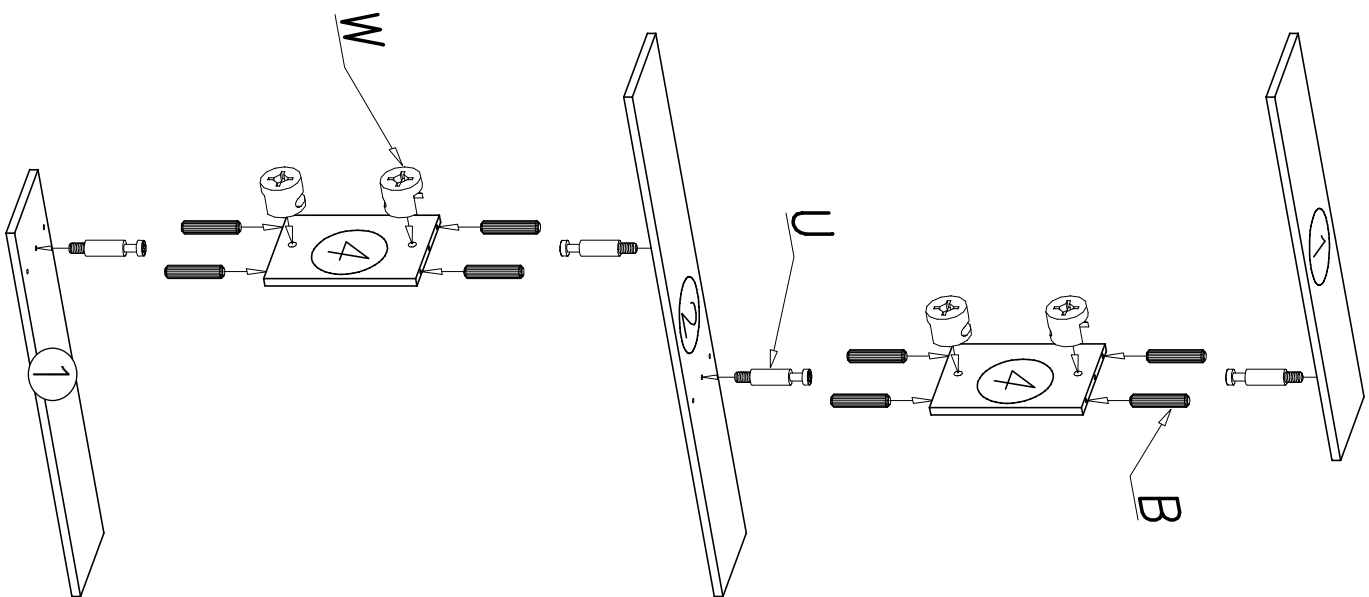

II

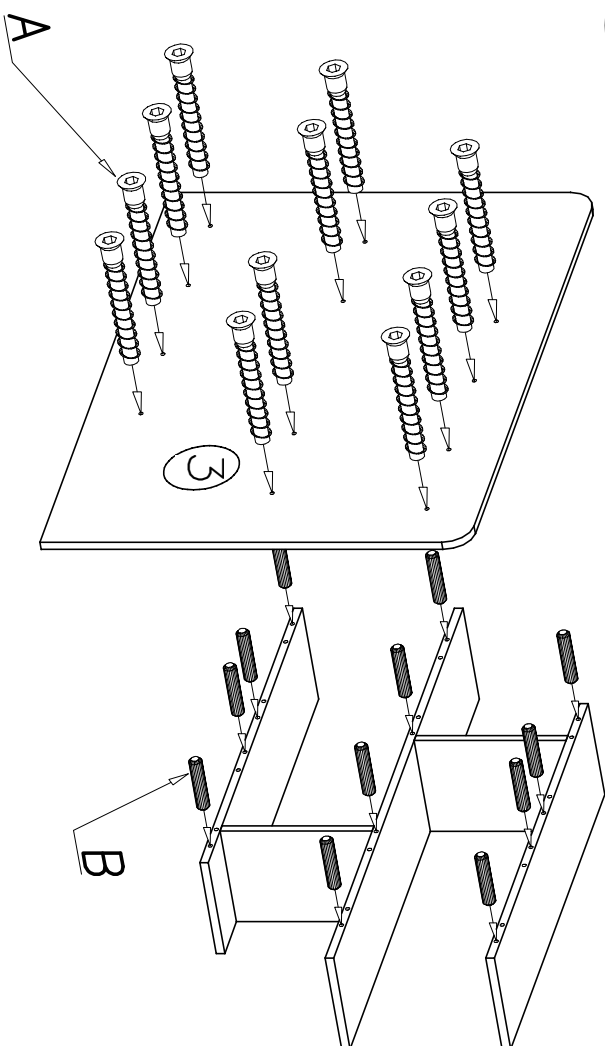

III

