

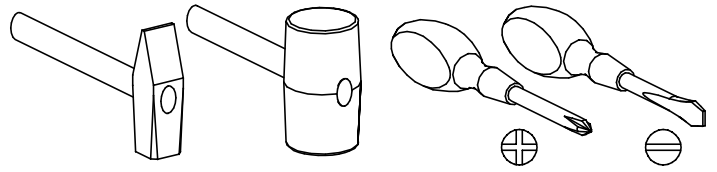

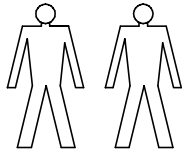

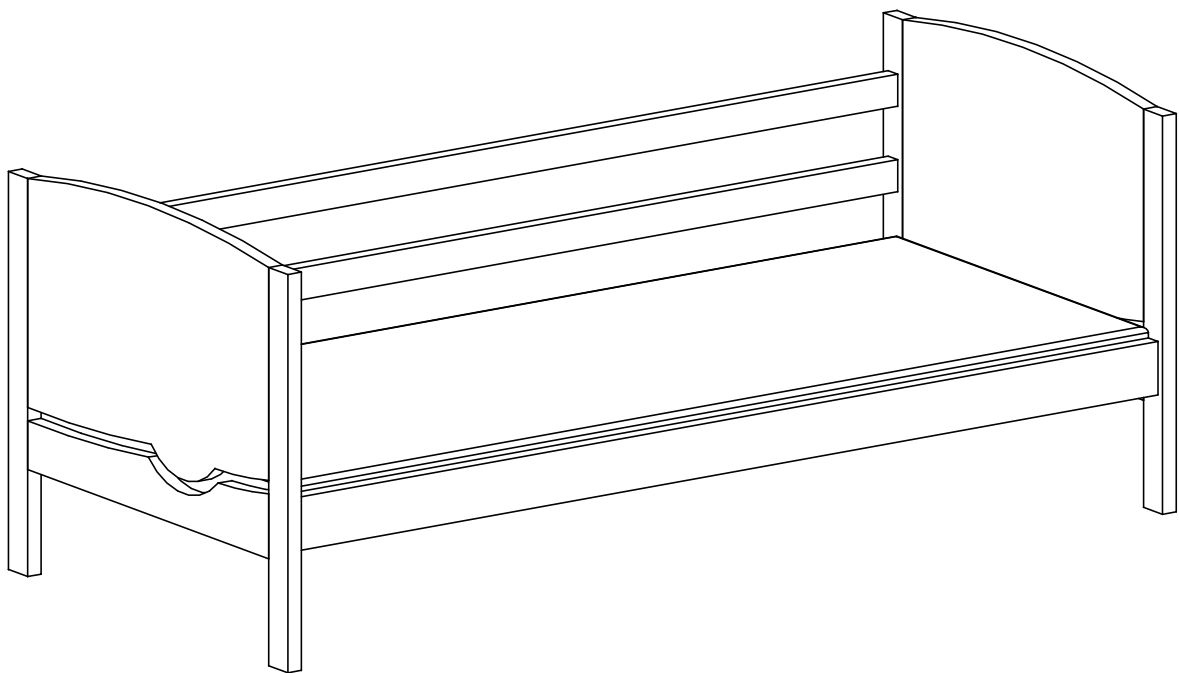

PRZED ROZPOCZĘCIEM MONTAŻU ZAPOZNAĆ SIĘ Z INSTRUKCJĄ

Narzędzia niezbędne do montażu (nie dostarczane przez producenta)

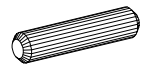

KEWIN

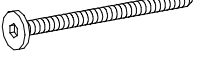
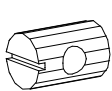

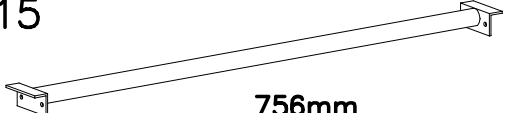
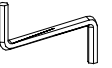
18 ø8 x20		19 ø10 x4		B2 ø7,8x35 x4		N17 10x82 x4		N8 M6x70 x12	
N9 10x13 x4		G9 4x35 x4		M15 756mm x1		W2 4mm x1			

I

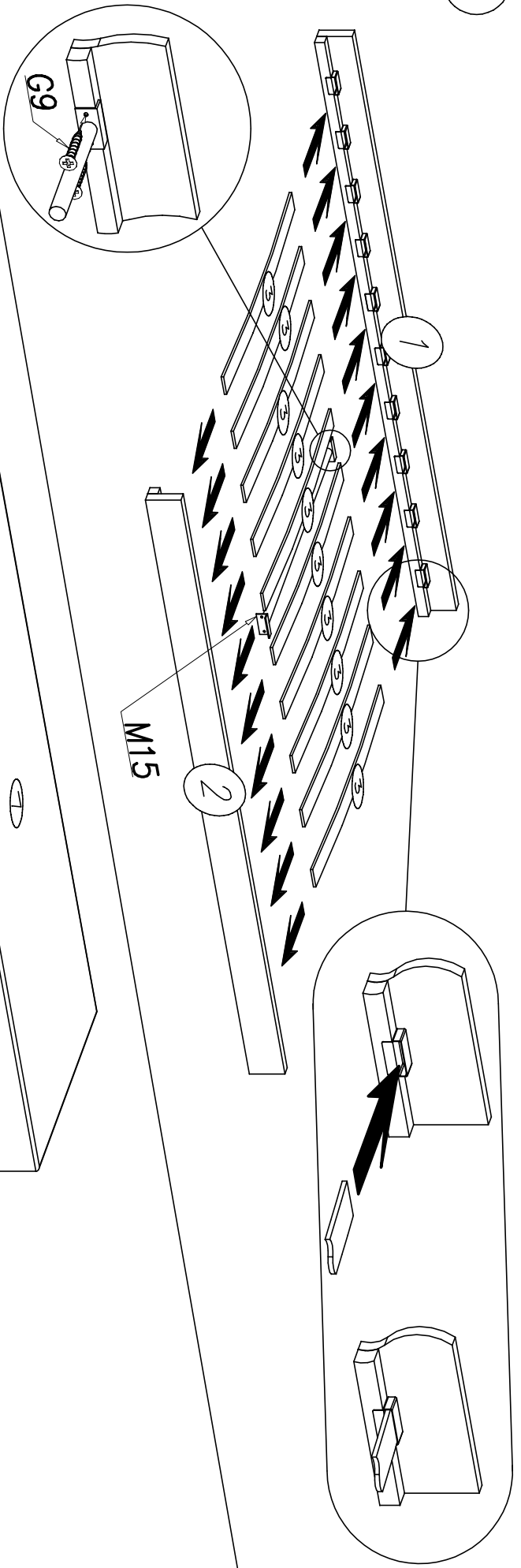

III

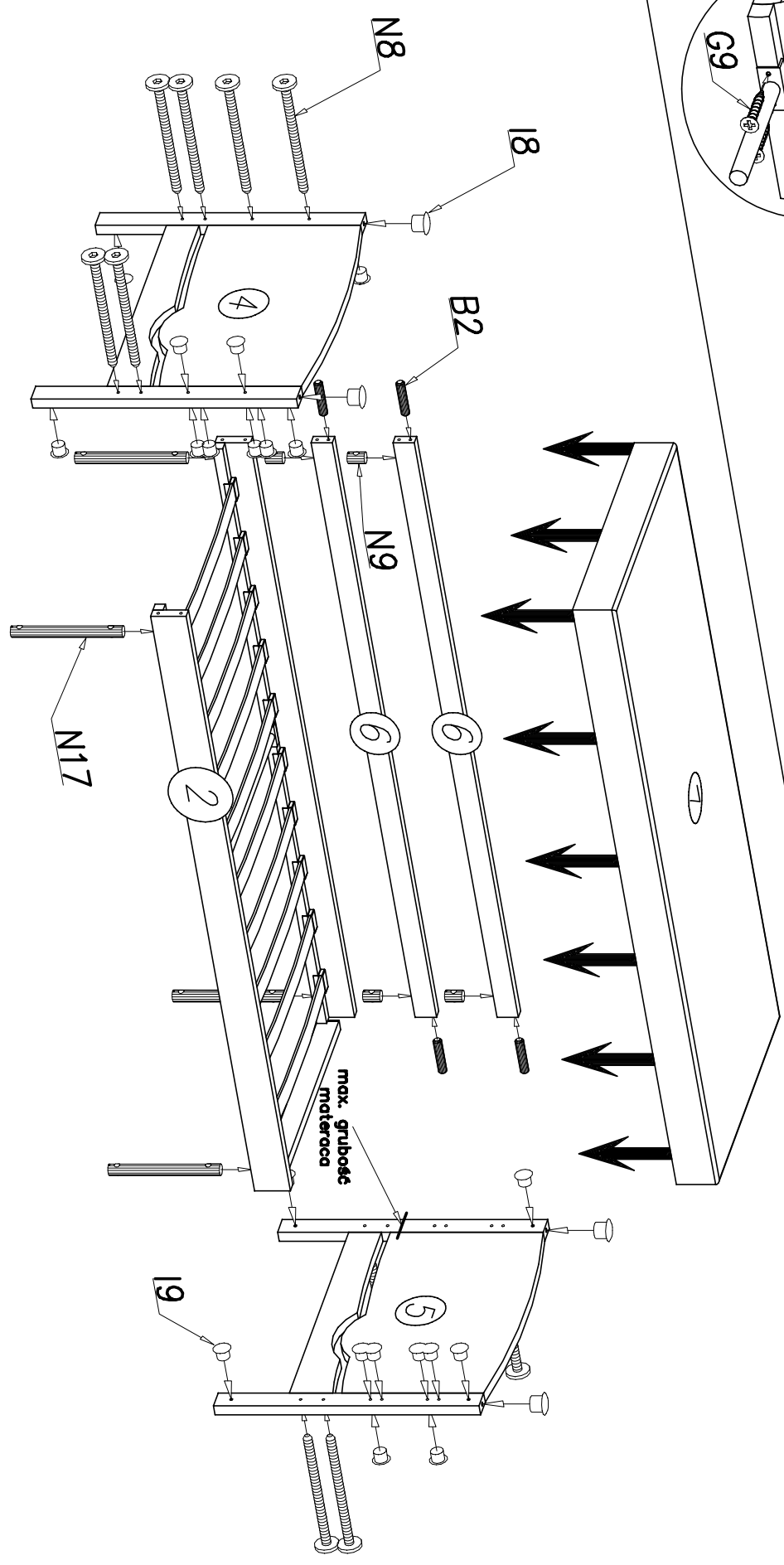

M15

mox. gruboć
mlteroca

19

5

2

6

6

N9

B2

18

N8

4

N17

